

United States District Court,
W.D. Arkansas, Texarkana Division.

EBAY INC,
Plaintiff.

v.

IDT CORP., IDT Telecom, Inc., Union Telecard Alliance, LLC, and Net12Phone, Inc,
Defendants.

No. 4:08-CV-04015-HFB

June 10, 2009.

Nicholas H. Patton, Geoffrey P. Culbertson, Patton, Tidwell & Schroeder, L.L.P., Texarkana, TX, Alan Heinrich, Andrei Iancu, Benjamin Wang, Eric B. Hanson, Morgan Chu, Samuel Lu, Irell Manella LLP, Los Angeles, CA, Babak Redjaian, Irell and Manella, LLP, Newport Beach, CA, Patricia L. Peden, Law Offices of Patricia L. Peden, Oakland, CA, for Plaintiff.

Conor Fitzgerald Farley, Jane Michaels, Holland and Hart LLP, Denver, CO, Donald A. Degnan, Timothy P. Getzoff, Holland Hart LLP, Boulder, CO, Damon Young, John M. Pickett, Young, Pickett & Lee, Texarkana, TX, for Defendants.

CLAIM CONSTRUCTION ORDER

HARRY F. BARNES, District Judge.

Table of Contents

I.	Background	1
II.	Claim Construction Principles	2
	A. Overview	2
	B. Claims	2
	C. Specification	4
	D. Prosecution History	6
III.	U.S. Patent No. 6,067,350	7
	A. Overview	7
	1. Background	8
	2. Disclosure	9
	B. The Asserted Claims	16
	C. Agreed Terms	20
	D. Disputed Terms and Phrases	21

1.	"commercial access provider ... of INTERNET" or "of digitized packet based network"	21
a)	The Parties' Proposed Constructions	22
b)	Discussion	22
(1)	The Claims	22
(2)	The Specification	24
(a)	Generic Internet Commercial Access Provider	24
(b)	Parties Arguments and Remainder of Specification	26
(3)	E-Mail, Voice and Facsimile Messages	32
(a)	E-Mail Messages	32
(b)	Voice and Facsimile Messages	33
(c)	The Embodiment of Fig. 4	39
(d)	The Embodiment of Fig. 5	41
(4)	eBay's "widely available" Arguments	42
(5)	Prosecution History	43
(6)	eBay-IDT's Proposed Construction Limits Claims to a Business	46
(7)	eBay-Use by Non-Subscribers	47
c)	Conclusion	47
2.	"node"	48
a)	The Parties' Proposed Constructions	48
b)	Discussion	49
c)	Conclusion	50
3.	"commercial access provider node," "commercial access nodes" and "provider node"	50
a)	The Parties' Proposed Constructions	51
b)	Discussion	51
c)	Conclusion	52
4.	"first commercial access provider node", "first provider node"	52
a)	The Parties' Proposed Constructions	53
b)	Discussion	53
c)	Conclusion	54
5.	"second commercial access provider node," "second provider node" and "further commercial access provider node"	54
a)	The Parties' Proposed Constructions	55
b)	Discussion	55
c)	Conclusion	57
6.	"digitized packet based network"	57
a)	The Parties' Proposed Constructions	57
b)	Discussion	58
c)	Conclusion	59

7.	"means to allow users to initiate a telephone communication with a desired telephone device identified by a telephone address"	59
a)	The Parties' Proposed Constructions	60
b)	Discussion	60
c)	Conclusion	66
8.	"appropriate digitized packet based communication channel," "appropriately process the signals for transmission"	67
a)	The Parties' Proposed Constructions	68
b)	Discussion	68
c)	Conclusion	71
IV.	U.S. Patent Nos. 5,974,414 and 6,631,399	71
A.	Overview	72
B.	Agreed Terms	73
C.	Asserted Claims of the '414 Patent	74
D.	Asserted Claims of the '399 Patent	75
E.	Disputed Terms and Phrases	76
1.	"digitally-encoded messages"	76
a)	The Parties' Proposed Constructions	77
b)	Discussion	80
c)	Conclusion	89
2.	"an automatic message distribution system"	90
a)	The Parties' Proposed Constructions	90
b)	Discussion	91
c)	Conclusion	91
3.	"distribution rule maintenance and access process"	92
a)	The Parties' Proposed Constructions	92
b)	Discussion	93
c)	Conclusion	95
4.	"an automatic message distribution daemon"	95
a)	The Parties' Proposed Constructions	95
b)	Discussion	96
c)	Conclusion	97
5.	"primary user," "primary user list," "secondary user," "secondary user list"	97
a)	The Parties' Proposed Constructions	98
b)	Discussion	99
(1)	Parties' Arguments	99
(2)	<i>Curtiss-Wright</i> - "Detailed Description of the Preferred Embodiments"	101
(3)	Claim Language	102
(4)	Specification- "main queue"	104

(5)	Specification-"primary users"	106
(6)	Specification-"secondary users"- "but only in the event that there are no primary users available"	106
(a)	When "there are no primary users available"	106
(b)	Threshold Values	107
(c)	Resolution	111
c)	Conclusion	116
V.	U.S. Patent No. 6,275,490	117
A.	Overview	117
B.	Agreed Terms	118
C.	The Asserted Claims	118
D.	Disputed Terms and Phrases	120
1.	"address information"	120
a)	The Parties' Proposed Constructions	120
b)	Discussion	120
c)	Conclusion	127
2.	"retrieving with a browser process executing on the computer system, address information usable in establishing a real-time audio communication connection with a destination" and "browser program code configured to obtain address information usable in establishing a real-time audio communication connection with a destination"	127
a)	The Parties' Proposed Constructions	128
b)	Discussion	130
c)	Conclusion	133
VI.	Order	134

I.

Background

eBay Inc. ("eBay") alleges, *inter alia*, that IDT Corp., IDT Telecom, Inc., Union Telecard Alliance, LLC and Net2Phone (Net2Phone) (collectively "IDT" or "defendants") have infringed certain claims of U.S. Patent No. 6,067,350 entitled "Long Distance Telephone Communication System and Method" ("the '350 patent").

Net2Phone counterclaims that eBay has infringed certain claims of the following patents:

1. U.S. Patent No. 6,275,490 entitled "Method and Apparatus for Establishing Communications From Browser Application" ("the '490 patent");
2. U.S. Patent No. 6,631,399 entitled "System and Method for Automated Received Message Handling and Distribution" ("the '399 patent"); and
3. U.S. Patent No. 5,974,414 entitled "System and Method for Automated Received Message Handling and

Distribution" ("the '414 patent").

On November 24, 2008, the parties filed their Joint Claim Construction and Prehearing Statement (Doc. No. 60). On January 7, 2009, eBay filed its Opening Brief on Claim Construction Regarding U.S. Patent No. 6,067,350 (Doc. No. 82). On January 7, 2009, Net2Phone filed its Opening Claim Construction Brief (Doc. No. 83). On January 21, 2009, the Defendants filed a Claim Construction Brief and Response to Plaintiff's Opening Claim Construction Brief for U.S. Patent 6,067,350 (Doc. No. 86). On January 21, 2009, eBay filed its Responsive Claim Construction Brief for Defendants' Counterclaim Patents '414, '399 and '490 (Doc. No. 87). On January 28, 2009, eBay filed its Reply in Support of its Proposed Claim Constructions Regarding Patent '350 (Doc. No. 91). On January 30, 2009, Net2Phone filed its Corrected Reply Claim Construction Brief for U.S. Patents '414, '399 and '490 (Doc. No. 92). On February 4, 2009, Defendants filed their Sur-Reply Claim Construction Brief for U.S. Patent '350 (Doc. No. 94). On February 4, 2009, eBay's Sur-Reply Brief on Claim Construction for Defendants' Counterclaim Patents '414, '399 and '490 (Doc. No. 95) was filed with the Court. On February 16, 2009, the parties filed their P.R. 4-5(d) Joint Claim Construction Chart ("JCCC") (Doc. No. 99).

II.

Claim Construction Principles

A. Overview

A patent is a fully integrated written instrument. *See* Markman v. Westview Instruments, Inc., 52 F.3d 967, 978 (Fed.Cir.1995) (*en banc*), *aff'd*, 517 U.S. 370 (1996). A patent, by statute, must provide a written description of the invention, a disclosure that would enable one of ordinary skill in the art to make and use the invention, and a disclosure of the best mode known to the inventor for practicing the invention. 35 U.S.C. s. 112(1). FN1 A patent must also contain claims "particularly pointing out and distinctly claiming the subject matter which the applicant regards as his invention." 35 U.S.C. s. 112(2). FN2 The claims of a patent provide the measure of a patentees' right to exclude others from practicing the claimed invention. 35 U.S.C. s. 154. FN3

FN1. 35 U.S.C. s. 112(1) provides:

The specification shall contain a written description of the invention, and of the manner and process of making and using it, in such full, clear, concise, and exact terms as to enable any person skilled in the art to which it pertains, or with which it is most nearly connected, to make and use the same, and shall set forth the best mode contemplated by the inventor of carrying out his invention.

FN2. 35 U.S.C. s. 112(2) provides:

The specification shall conclude with one or more claims particularly pointing out and distinctly claiming the subject matter which the applicant regards as his invention.

FN3. 35 U.S.C. s. 154(a)(1) provides:

Every patent shall contain a short title of the invention and a grant to the patentee, his heirs or assigns, of the right to exclude others from making, using, offering for sale, or selling the invention throughout the United States or importing the invention into the United States, and, if the invention is a process, of the right to exclude others from using offering for sale or selling throughout the United States, or importing into the United States, products made by that process, referring to the specification for the particulars thereof.

B. Claims

Primary claim construction principles are discussed and explained in *Phillips v. AWH Corp.*, 415 F.3d 1303 (Fed.Cir.2005) (*en banc*). Among those are that "[i]t is a 'bedrock principle' of patent law that 'the claims of a patent define the invention to which the patentee is entitled the right to exclude.'" *Phillips*, 415 F.3d at 1312, (quoting *Innova/Pure Water, Inc. v. Safari Water Filtration Sys., Inc.*, 381 F.3d 1111, 1115 (Fed.Cir.2004), and citing *Vitronics Corp. v. Conceptronic, Inc.*, 90 F.3d 1576, 1582 (Fed.Cir.1996)). *See also* *CLAS, Inc. v. Alliance Gaming Corp.*, 504 F.3d 1356, 1358 (Fed.Cir.2007) ("The claims of the patent establish and limit the patentee's right to exclude ..."); *Renishaw PLC v. Marposs Societa' per Azioni*, 158 F.3d 1243, 1248 (Fed.Cir.1998) (claim construction "begins and ends" with the actual words of the claims). "That principle has been recognized since at least 1836, when Congress first required that the specification include a portion in which the inventor 'shall particularly specify and point out the part, improvement, or combination, which he claims as his own invention or discovery.'" *Phillips*, 415 F.3d at 1312. *See* *Gillespie v. Dywidag Sys. Int'l, USA*, 501 F.3d 1285, 1289 (Fed.Cir.2007) ("The claims of a patent define what is protected, i.e., what a patentee has the right to exclude the public from making, using, importing, offering for sale, or selling.").

"[T]he words of a claim 'are generally given their ordinary and customary meaning,'" and "the ordinary and customary meaning of a claim term is the meaning that the term would have to a person of ordinary skill in the art in question at the time of the invention, *i.e.*, as of the effective filing date of the patent application." *Phillips*, 415 F.3d at 1312-1313. *See* *Gillespie*, 501 F.3d at 1291. "That starting point is based on the well-settled understanding that inventors are typically persons skilled in the field of the invention and that patents are addressed to and intended to be read by others of skill in the pertinent art." *Phillips*, 415 F.3d at 1313. "Importantly, the person of ordinary skill in the art is deemed to read the claim term not only in the context of the particular claim in which the disputed term appears, but in the context of the entire patent, including the specification." *Id.*

"In some cases, the ordinary meaning of claim language as understood by a person of skill in the art may be readily apparent even to lay judges, and claim construction in such cases involves little more than the application of the widely accepted meaning of commonly understood words." *Id.* at 1314. Thus, in some instances, "general purpose dictionaries may be helpful," but, as the court explained, "[i]n many cases that give rise to litigation ... determining the ordinary and customary meaning of the claim requires examination of terms that have a particular meaning in a field of art." *Id.* "Because the meaning of a claim term as understood by persons of skill in the art is often not immediately apparent, and because patentees frequently use terms idiosyncratically, the court looks to 'those sources available to the public that show what a person of skill in the art would have understood disputed claim language to mean.'" *Id.*, (quoting *Innova*, 381 F.3d at 1116). "Those sources include 'the words of the claims themselves, the remainder of the specification, the prosecution history, and extrinsic evidence concerning relevant scientific principles, the meaning of technical terms, and the state of the art.'" *Id.* (quoting *Innova*, 381 F.3d at 1116).

Thus, the claim construction process begins with the language used in the claims because "[q]uite apart from the written description and the prosecution history, the claims themselves provide substantial guidance as to the meaning of particular claim terms." *Id.* "Other claims of the patent in question, both asserted and unasserted, can also be valuable sources of enlightenment as to the meaning of a claim term. Because claim terms are normally used consistently throughout the patent, the usage of a term in one claim can often illuminate the meaning of the same term in other claims." *Id.* (citation omitted).

"Differences among claims can also be a useful guide in understanding the meaning of particular claim terms." *Id.* That is referred to as "claim differentiation." "For example, the presence of a dependent claim that adds a particular limitation gives rise to a presumption that the limitation in question is not present in the independent claim." *Id.* at 1314-15. However, claim differentiation is a guide, not a rigid rule, and there are exceptions, as discussed below.

C. Specification

The specification nevertheless remains important in claim construction. "The claims, of course, do not stand alone. Rather, they are part of 'a fully integrated written instrument,' consisting principally of a specification that concludes with the claims. For that reason, claims 'must be read in view of the specification, of which they are a part.' ... [T]he specification 'is always highly relevant to the claim construction analysis. Usually, it is dispositive; it is the single best guide to the meaning of a disputed term.'" Phillips, 415 F.3d at 1315 (citations omitted). *See also* Chamberlain Group, Inc. v. Lear Corp., 516 F.3d 1331, 1335 (Fed.Cir.2008) ("Intrinsic evidence, that is the claims, written description, and the prosecution history of the patent, is a more reliable guide to the meaning of a claim term than are extrinsic sources like technical dictionaries, treatises, and expert testimony."); Osram GmbH v. United States Int'l Trade Comm'n, 505 F.3d 1351, 1356 (Fed.Cir.2007) ("The patent specification is the primary resource for determining how an invention would be understood by persons experienced in the field.").

In particular, "[c]onsistent with that general principle," the cases recognize that (1) "the specification may reveal a special definition given to a claim term by the patentee that differs from the meaning it would otherwise possess. In such cases, the inventor's lexicography governs," and (2) "[i]n other cases, the specification may reveal an intentional disclaimer, or disavowal, of claim scope by the inventor. In that instance as well, the inventor has dictated the correct claim scope, and the inventor's intention, as expressed in the specification, is regarded as dispositive." *Id.* at 1316. *See* Sinorgchem Co., Shandong v. United States Int'l Trade Comm'n, 511 F.3d 1132, 1136 (Fed.Cir.2007) ("Our opinions have repeatedly encouraged claim drafters who choose to act as their own lexicographers to clearly define terms used in the claims in the specification.").

However, two claim construction principles are (1) claims are read in light of the specification, but (2) limitations from the specification must not be read into the claims. The line between the two is not always clear. *See* Comark Commc'ns, Inc. v. Harris Corp., 156 F.3d 1182, 1186-87 (Fed.Cir.1998) ("[T]here is sometimes a fine line between reading a claim in light of the specification, and reading a limitation into the claim from the specification"). In *Phillips*, the Federal Circuit advised that the "line between construing terms and importing limitations can be discerned with reasonable certainty and predictability if the court's focus remains on understanding how a person of ordinary skill in the art would understand the claim terms. For instance, although the specification often describes very specific embodiments of the invention, we have repeatedly warned against confining the claims to those embodiments. In particular, we have expressly

rejected the contention that if a patent describes only a single embodiment, the claims of the patent must be construed as being limited to that embodiment. That is not just because section 112 of the Patent Act requires that the claims themselves set forth the limits of the patent grant, but also because persons of ordinary skill in the art rarely would confine their definitions of terms to the exact representations depicted in the embodiments." 415 F.3d at 1323 (citations omitted). *See also* Miken Composites, L.L.C. v. Wilson Sporting Goods Co., 515 F.3d 1331, 1337 (Fed.Cir.2008) (discussing "inset" as used in the specification and claims).

The Federal Circuit also advised: "To avoid importing limitations from the specification into the claims, it is important to keep in mind that the purposes of the specification are to teach and enable those of skill in the art to make and use the invention and to provide a best mode for doing so. One of the best ways to teach a person of ordinary skill in the art how to make and use the invention is to provide an example of how to practice the invention in a particular case. Much of the time, upon reading the specification in that context, it will become clear whether the patentee is setting out specific examples of the invention to accomplish those goals, or whether the patentee instead intends for the claims and the embodiments in the specification to be strictly coextensive. The manner in which the patentee uses a term within the specification and claims usually will make the distinction apparent." Phillips, 415 F.3d at 1323 (citations omitted). *See also* Baldwin Graphic Sys., Inc. v. Siebert, Inc., 512 F.3d 1338, 1345 (Fed.Cir.2008) ("As with any other type of claim, courts must carefully avoid importing limitations from the specification into method claims.... Nonetheless the specification informs the meaning of the claims.").

The Federal Circuit has acknowledged that "[i]n the end, there will still remain some cases in which it will be hard to determine whether a person of skill in the art would understand the embodiments to define the outer limits of the claim term or merely to be exemplary in nature. While that task may present difficulties in some cases, we nonetheless believe that attempting to resolve that problem in the context of the particular patent is likely to capture the scope of the actual invention more accurately than either strictly limiting the scope of the claims to the embodiments disclosed in the specification or divorcing the claim language from the specification." Phillips, 415 F.3d at 1323-24.

D. Prosecution History

The words in the claim may also be interpreted in light of the prosecution history, if in evidence. *See* Teleflex, Inc. v. Ficosa N. Am. Corp., 299 F.3d 1313, 1324 (Fed.Cir.2002). "Like the specification, the prosecution history provides evidence of how the PTO and the inventor understood the patent. Furthermore, like the specification, the prosecution history was created by the patentee in attempting to explain and obtain the patent." Phillips, 415 F.3d at 1317 (citations omitted). *See* Regents of Univ. of Cal. v. Dakocytomation Cal., Inc., 517 F.3d 1364, 1373 (Fed.Cir.2008).

"Yet because the prosecution history represents an ongoing negotiation between the PTO and the applicant, rather than the final product of that negotiation, it often lacks the clarity of the specification and thus is less useful for claim construction purposes." Phillips, 415 F.3d at 1317. "Nonetheless, the prosecution history can often inform the meaning of the claim language by demonstrating how the inventor understood the invention and whether the inventor limited the invention in the course of prosecution, making the claim scope narrower than it would otherwise be. *Id.* *See* Gillespie, 501 F.3d at 1291 ("The patentee is held to what he declares during the prosecution of his patent").

The '350 patent entitled, "Long Distance Telephone Communication System and Method," issued on May 23, 2000, to Alastair T. Gordon, from Application No. 08/659,672, filed on June 5, 1996. The face of the patent indicates that the application maturing into the '350 patent-in-suit was filed as a continuation of application No. 08/387,162 filed on February 13, 1995, now U.S. Pat. No. 5,608,786.

A. Overview

The '350 patent, under the heading "Field of the Invention," says that it "relates to a method and system for unified messaging services, and in particular relates to a system and method which makes long distance voice communication voice mail, facsimile mail and E-Mail conveniently accessible to receive as well as to transmit and to allow crossover in both the type of document that is received or transmitted. Long distance telephone communications using INTERNET are available to conventional telephone subscribers." FN4 '350 patent, col. 1, lines 10-18.

FN4. It is common to refer to " *the* Internet." The '350 patent, however, consistently does not use the word "the."

According to the abstract:

The present invention relates to a long distance telephone communication system which is convenient and cost effective. This system advantageously combines or makes use of existing communication channels or networks. The system and method relies on an intermediate leg of the distribution network being an INTERNET segment. Conventional PSTN telephone communication is typically used for initial and final legs. Real time voice telephone communications are completed by the system. Telephone to telephone long distance communications use INTERNET between two commercial providers, with these commercial providers interacting seamlessly with conventional telephones, thereby making the system widely available to telephone subscribers.

The parties disagree over what the '350 patent actually discloses and claims. The description here is intended simply as background and is not intended to adopt one party or the other's interpretation of the specification and drawings. Each of the parties' contentions will be addressed in more detail below.

1. Background

Under the heading "Background of the Invention," the '350 patent explains that the "INTERNET(TM) now provides a network where a subscriber typically contracts with a commercial access provider (CAP) and obtains an Internet address as well as the capability to send and receive E-Mail on Internet and perform other functions which Internet supports. The subscriber typically uses his personal computer and modem to contact the commercial access provider using the public switched telephone network (PSTN), and once connected to Internet, performs the desired functions. The CAP provides an E-Mail box for the subscriber and the subscriber, when connected to the CAP, can review the contents of this electronic mailbox." FN5 '350 patent, col. 1, lines 21-32.

FN5. Although the specification uses the "(TM)" symbol indicating a trademark, it seems clear that the specification overall is referring to the generic Internet.

The '350 patent also states that "E-Mail systems have been available for many years and although they provide a very cost effective alternative to facsimile transmissions, the popularity of E-Mail does not nearly approach the popularity of voice and facsimile messaging and the number of users is many times lower." FN6 '350 patent, col. 1, lines 38-42. The patentee says that prior U.S. Patent Nos. 4,713,837, 4,922,518, 4,942,599 and 4,969,184 disclose systems for more efficient transmission and/or retrieval of facsimile communications.

FN6. The specification also uses the form "E-Mail" or "E-mail," as opposed to the more common forms, *i.e.* "e-mail" or "email," used today. The form "E-Mail" or "E-mail" is preserved when quoting from the specification.

The '350 patent further explains that "[c]ompanies have examined the approaches for conducting business and, in many cases, it is now felt that certain individuals within the company require their own private facsimile address as well as a convenient mechanism for receiving voice mail." According to the patent, "[t]he present invention has recognized the need for a system of transmission and central approach for combining these different message types. The invention also allows the many millions of telephone and facsimile machines throughout the world to be more cost effectively accessible by other telephones, facsimile machines, and computers and where the message type can be in addition to a traditional facsimile message." '350 patent, col. 1, line 53-col. 2, line 3.

2. Disclosure

Under the heading "Summary of the Invention," the '350 patent explains:

A messaging system according to the present invention having a bank of direct-in-dial (DID) telephone lines associated with a public switched telephone network and a computer system which also acts as a commercial access provider for the Internet or other data communication networks through which digital messages can be delivered. The computer system provides each subscriber with an E-mail address and account for the data communication network, as well as a fax telephone address and a voice mail telephone address, where a communication addressed to any of the addresses results in the computer system receiving and storing the particular message in an electronic messaging mailbox for retrieval by the respective subscriber.

'350 patent, col. 2, lines 6-19. In the "Detailed Description of the Preferred Embodiments," the patentee explains that a "subscriber" (the parties dispute whether a user must be a "subscriber") is provided, for example, with the following:

Internet Address: gordon@toronto.unipost.com

Personal Mailbox Number: 1-416-555-1234

Personal ID Number or password: 63265

'350 patent, col. 4, lines 46-50.

The specification under the heading "Summary of the Invention" further explains that any "subscriber" may use the PSTN to retrieve voice mail, e-mail, data files, or faxes from a single source, and that others may leave voice, fax or other messages for a "subscriber" by using the telephone number associated with the "subscriber's electronic message mailbox":

The computer system is accessible to any subscriber using the public switched telephone network and/or the data network for retrieval of communications stored on behalf of the subscriber or a summary of the communications whereby the subscribers may contact a single automated source for retrieval of voice mail, E-mail, data files, or facsimile transmissions received on its behalf by the computer system. Similarly, the system is accessible to anyone wishing to leave a voice, facsimile, or other message for the subscriber by dialing the telephone number associated with the subscriber's electronic message mailbox. As a result, data networks, such as Internet, are accessible by devices other than computers, namely by telephones and facsimile terminals.

'350 patent, col. 2, lines 20-33.

Although Fig. 5 is the embodiment most germane to the asserted claims, the other drawing figures and accompanying description are helpful in putting that embodiment, as well as the parties' arguments, in context.

Turning first to Fig. 1, which is described as "an overview of the unified messaging service and how it can interact with a data communication network," '350 patent, col. 4, lines 10-11:

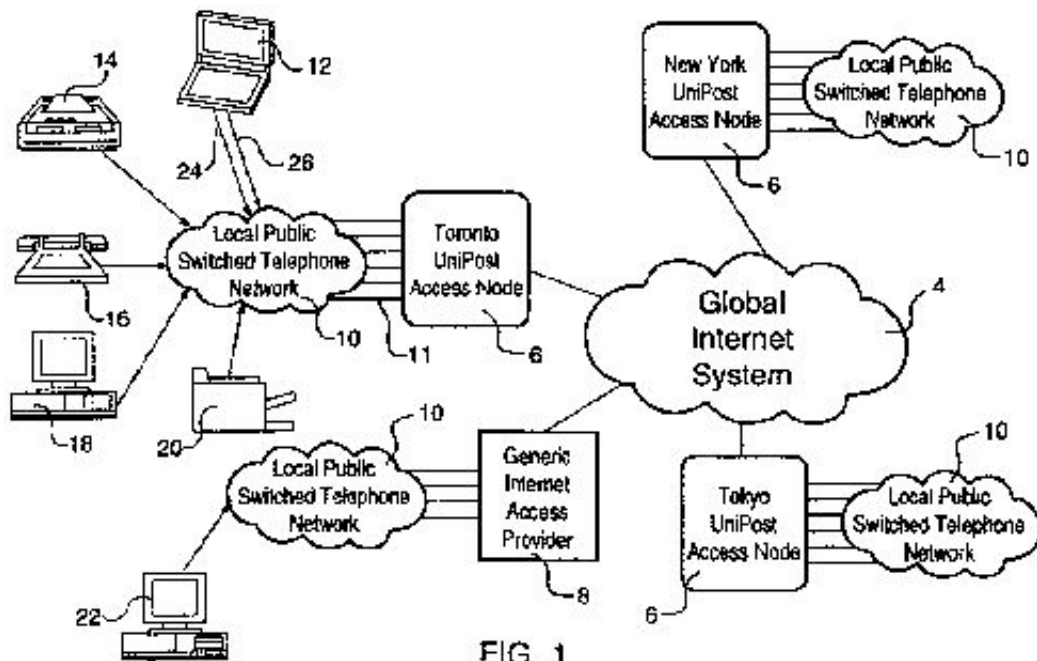

FIG. 1

FIG. 1

the specification explains that the "Internet 4" "has a number of Internet commercial access providers (CAPs) 8 which each have a host of subscribers who then have access to the various services of Internet typically using their personal computers. The conventional Internet access provider would provide each subscriber with an Internet address and password number for retrieval of E-Mail. One such subscriber 22 is shown using the local public switched telephone network 10 to gain access to the generic Internet CAP for transferring a file to E-Mail subscriber "gordon@toronto.UniPost.com" indicated as 12. This is via the Toronto UniPost Access Node 6, which includes the electronic Mailbox of Gordon." '350 patent, col. 5, lines 17-30. The specification further explains that "Gordon can either be alerted that an E-Mail communication has been received or may call in to the UniPost Access Node 6 from time to time, as indicated by line 24, go through the necessary protocol with the UniPost Access Node 6 or any UAN worldwide, and eventually receive the E-Mail, or other voice, facsimile, or other messages indicated by line 26." '350 patent, col. 5, lines 30-36.

The specification also explains that "[m]essages to the UniPost Internet subscriber 12 can also be made from a facsimile machine 14, from a telephone set 16, from a computer modem connection indicated as 18, or a message via Binary File transfer (BFT) indicated by the apparatus 20," '350 patent, col. 5, lines 37-41, through a local PSTN 10. According to the patent, "both voice messages and facsimile messages are sent to the same telephone address" and node 6 distinguishes between the two. The patent explains that "the communications can be accessed by the UniPost Internet subscriber 12 making contact with the Toronto UniPost Access Node 6 or any other UAN worldwide and retrieving of communications that have been received for the subscriber." '350 patent, col. 5, lines 51-55.

The specification summarizes the operation as follows:

Thus, to a caller calling a UniPost subscriber from a telephone, the UAN will behave like a voice mail system. For callers calling a UniPost subscriber from a facsimile machine, the UAN will behave like a receiving facsimile machine. Likewise, the subscriber can use a telephone, facsimile machine or computer to retrieve his messages from any UAN. A telephone will facilitate playback and management of voice message, indication of other message types and mailbox status, and possibly text-to-speech conversion of E-Mail. A facsimile machine will facilitate retrieval of facsimile messages, display of E-Mail, and notification of other message types and mailbox status. A computer will facilitate retrieval and management of all message types, including voice, facsimile, E-Mail, video and any other file type. UniPost software resident in the computer will allow for the convenient retrieval, playback, viewing, filing and general management of all message types.

'350 patent, col. 6, lines 9-25.

Fig. 2 is described as "an overview showing certain features of the system, and in particular the type of structure used to unify the various communication messages of a subscriber and a common electronic mailbox and the various means for retrieval of the information." '350 patent, col. 4, lines 12-16:

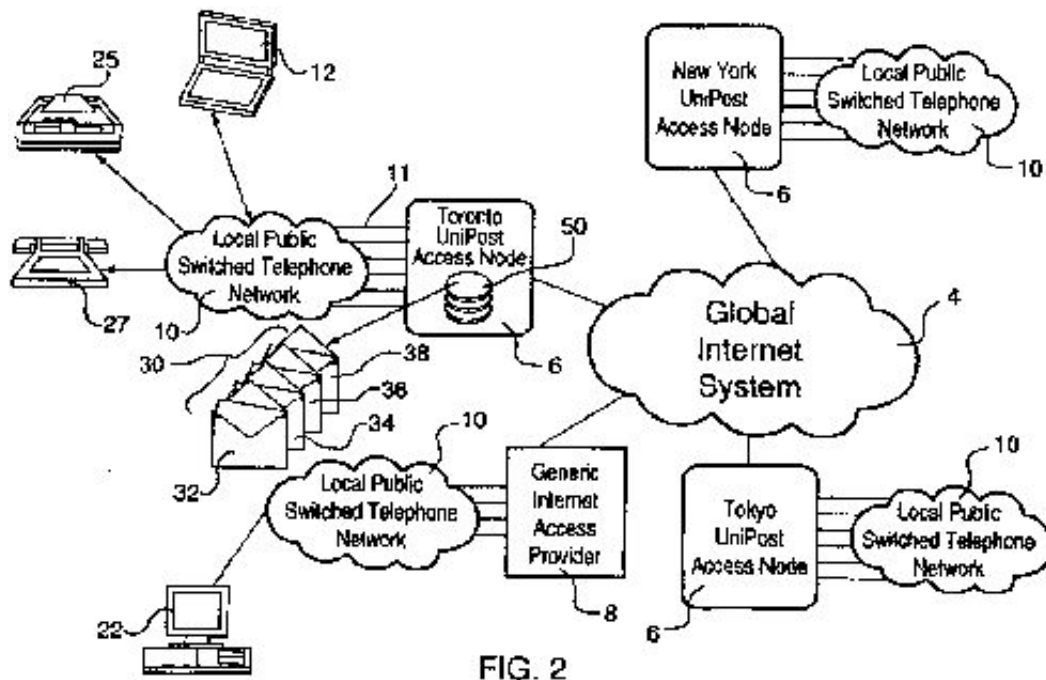

FIG. 2

FIG. 2

The specification explains that in this illustrated embodiment, node 6 includes a hard disk 50 which provides "each subscriber with a separate electronic message mailbox, generally shown as 30. Within the electronic mailbox is, typically, a facsimile in-box 32, a voice in-box 34, an E-Mail box 36 and a facsimile out-box 38." '350 patent, col. 6, lines 41-44. According to the specification, "[t]he retrieval of messages in the electronic mailbox using a computer and modem shown as 12 can follow the conventional practice, however, E-Mail, voice, facsimile, and other message types can be retrieved by the computer. The facsimile message can be processed using an optical character recognition arrangement within the UniPost 6 to provide a text file, or it can be merely sent as a graphic image.... Furthermore, voice messages may be sent to the computer and replayed through speakers or the voice messages may be converted into text communications." '350 patent, col. 6, lines 51-63. The specification explains that facsimile machine 25 or telephone 27 may also be used to retrieve messages- "if the subscriber is at the facsimile machine 25 and wishes to retrieve messages, he can contact the Toronto UniPost Access Node 6, key in his particular password, and direct the UniPost Access Node to send the facsimile message to the machine preferably directly without forming a further communication. On the other hand, the subscriber could use the telephone set 27 to get a summary of messages received as well as any voice messages, and then direct the Toronto UniPost Access Node 6 to send E-Mail or facsimile messages to the facsimile machine 25." '350 patent, col. 6, line 64 -col. 7, line 8.

Fig. 3 is described as "an overview of how the system can be used to effectively connect a subscriber to the data communication network and to his individual electronic mailbox for effective retrieval of messages." '350 patent, col. 4, lines 17-20:

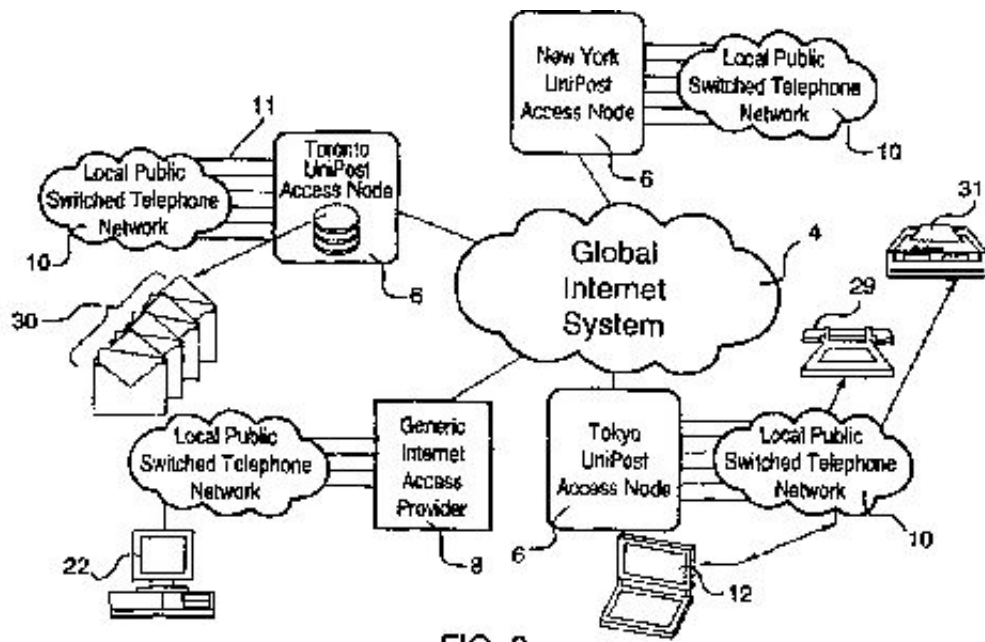

FIG. 3

FIG. 3

The specification explains that:

In this case, the "gordon@toronto.unipost.com" UniPost Internet subscriber, generally indicated as 12, is in Japan and uses the local public switched telephone network 10 to contact the Tokyo UniPost Access Node 6. After proper identification of the subscriber, the Tokyo UniPost Access Node uses Internet 4 to access the electronic mailbox 30 of the subscriber and allows retrieval of the various contents of the various boxes. For example, the personal computer 12 can receive voice messages, facsimile messages, E-Mail and file transfer, or the Internet subscriber 12 could use the telephone set 29 to retrieve voice messages and possibly the voice summary of messages received and have them played back to him. Furthermore, E-Mail or facsimile messages can be directed by the subscriber to a facsimile machine, shown as 31. Therefore, both access to the system and retrieval of information is not limited to a single technology, but can make use of a personal computer and modem connection, a telephone set connection, or a facsimile machine connection with one of the UniPost Access Nodes for both accessing a mailbox and retrieving the contents thereof.

'350 patent, col. 7, lines 27-47. The specification further explains that in this example subscriber 12 is able to retrieve messages while in Tokyo using local PSTN 10 thus reducing the need for a long distance telephone call:

It can also be appreciated that the example shown in FIG. 3 has allowed the subscriber 12 to form a relatively local connection using the public switched telephone network 10 to contact the Tokyo UniPost Access Node 6. This is then connected to the Toronto UniPost Access Node 6 and the electronic mailbox of the subscriber via an Internet or dedicated data communication channel. Information is retrieved from the mailbox and provided to the UniPost Access Node, also by this data communication channel provided by Internet. In contrast to a single UniPost Access Node, the multiple access nodes, shown in FIG. 3, advantageously use the dedicated data communication network to interconnect the access nodes and reduces the need for long distance telephone communications with a particular computer.

'350 patent, col. 7, lines 47-61.

Fig. 4 is described as "an overview showing an effective manner for delivering a facsimile in a cost effective manner." '350 patent, col. 4, lines 21-22:

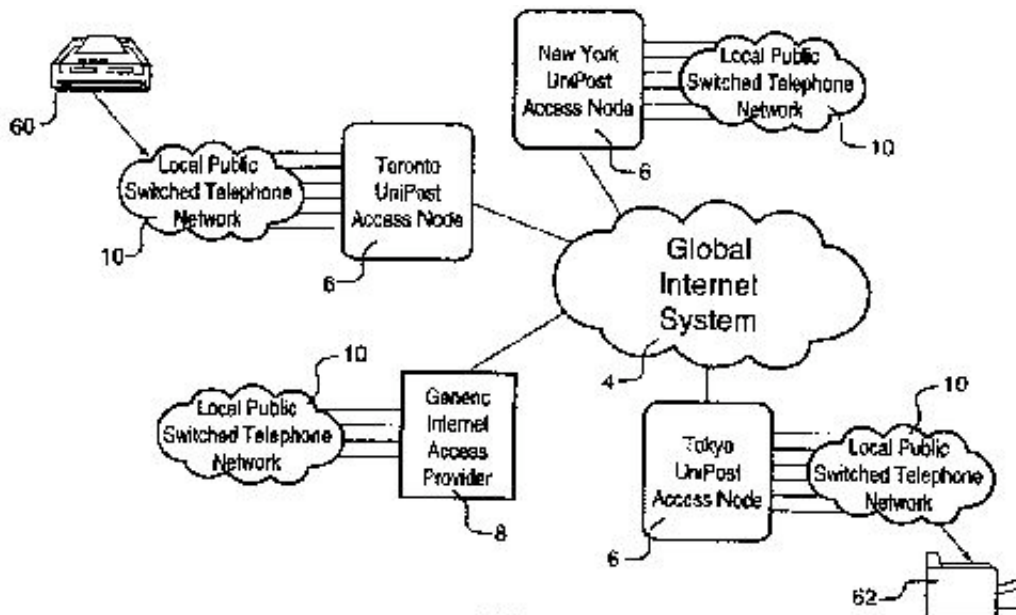

FIG. 4

FIG. 4

The specification explains that

In this case, the transmission is sent from the facsimile machine 60 via the public switched telephone network 10 to the UniPost Access Node 6.... Therefore, in this case, the user provides the direction to initiate the contact with the Toronto UniPost Access Node 6. The Toronto UniPost Access Node 6 recognizes that it is a transmission to be received in Japan, receives the transmission, and then uses the Internet data transmission system 4 to transfer the facsimile to the Tokyo UniPost Access Node 6. The Tokyo UniPost Access Node 6 then uses the public switched telephone network 10 to deliver the UniPost to the particular address identified in the original transmission. With this arrangement, the facsimile has been recognized as being a data transmission and redirected to make use of a data communication system and then receive the communication in a geographical location much closer whereby the local public switched telephone network may be effectively used.

'350 patent, col. 8, lines 9-29.

Fig. 5 is the embodiment eBay particularly focuses on, and which is described as "a schematic of how the system can be used to complete a voice communication channel to a telephone set in a distant geographical location." '350 patent, col. 4, lines 23-26:

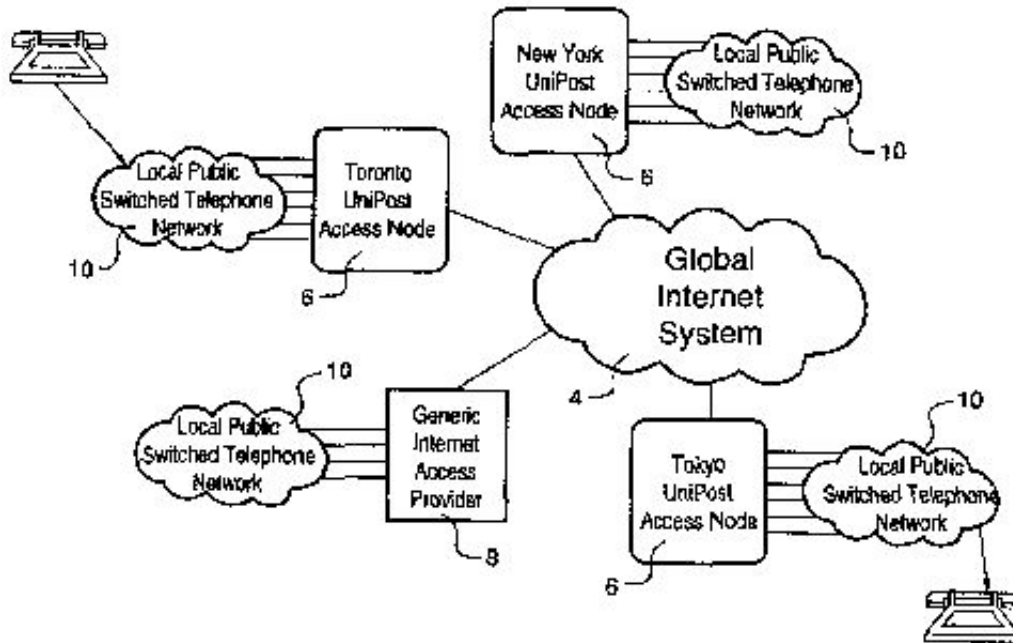

FIG. 5

FIG. 5

The specification explains that:

FIG. 5 also shows how this UniPost system can be used for providing a direct telephone link using the data transmission network involving Internet. In this case, voice is transmitted digitally and a live communication is maintained between Toronto UniPost Access Node 6 and Tokyo UniPost Access Node 6. Each of these have formed a live communication with the originating telephone set and the receiving telephone set. This can thus provide the subscriber with a further cost advantage in completing his international communications or other long distance communications.

The discount long distance voice messaging requires that each UniPost Access Node is able to accept and digitize voice calls. The actual data communication link utilizes protocols and routing logic which ensures that the digitized voice packets remain in sequence from sender to recipient. As with long distance facsimile calls, the call originator will dial the local UniPost Access Node and enter his account and the number of the recipient. The UniPost Access Node will establish a packet path between the originating UniPost Access Node and the destination UniPost Access Node closest to the recipient. The destination UniPost Access Node will then place a local call to the recipient and deliver the voice message.

'350 patent, col. 9, lines 1-23.

B. The Asserted Claims

eBay asserts claims 1, 2, 5, 6, 9 (dependent on claim 8), 11 (dependent on claim 10), 12, 14, 17 and 18 (Doc. No. 82 at 10 FN7). The claims are reproduced below for reference:

FN7. All document pages cited refer to page numbers in the filed document's CM/ECF heading.

1. A method of forming a long distance communication channel between two telephone devices each of which are connected to a PSTN, said method comprising a user of one of said telephone devices initiating and establishing a telephone communication with a first commercial access provider node of INTERNET and providing thereto a telephone address, using INTERNET to establish a communication channel between said first commercial access provider node and a second commercial access provider node of INTERNET and providing said telephone address to said second commercial access provider node, said second commercial access provider node using said telephone address and a telephone dial out capability of said second commercial access provider node to establish a communication with a telephone device at the telephone address using a PSTN, and using the INTERNET communication channel to link said telephone devices and form a real time voice communication between said telephone devices.
2. A method as claimed in claim 1 including, after initiating said telephone communication with said first commercial access provider node, said first commercial access provider node communicates with said user to establish authorization for completing a long distance communication.
5. A method as claimed in claim 4 wherein signals transmitted between said commercial access nodes using INTERNET are encrypted.
6. A method as claimed in claim 1 wherein the originating telephone device has a predetermined arrangement with said first commercial access provider node and said second telephone device has no prior relationship with either of said commercial access provider nodes.
8. A method of establishing a long distance telephone communication between an initiating telephone device and a receiving device telephone identified by a telephone address, said method comprising using a PSTN to initiate a telephone communication with a commercial access provider node of a digitized packet based network and provide the node with said telephone address, said commercial access provider node causing a real time voice communication channel to be formed between said telephone devices, which communication channel includes an initial PSTN segment between the initiating telephone device and said commercial access provider node a digitized packet based network segment between said commercial access provider node, and a further commercial access provider node and a PSTN segment between said further commercial access provider node and the telephone device identified by the telephone address, wherein the further commercial access provider node uses the telephone address and the PSTN to initiate

the PSTN segment therebetween. [paragraphing added by the parties]

9. A method as claimed in claim 8 wherein said telephone devices are conventional telephones.

10. A method of forming a long distance telephone communication between a first telephone device and a second telephone device which communication is capable of transmitting real time voice communications similar to existing long distance voice telephone communications, comprising the steps of

forming an initial telephone link between the first telephone device and a commercial access provider node of a digitized packet based network and providing thereto a telephone address of the second telephone device,

said commercial access provider forming an appropriate digitized packet based communication channel with a further commercial access provider node located in closer proximity to the location of the second telephone device and providing thereto said telephone address,

said further commercial access provider establishing a telephone link with said second telephone device using said telephone address,

and then linking said telephone devices using said digitized packet based communication channel thereby forming a real time voice communication between said telephone devices. [paragraphing added by the parties]

11. A method as claimed in claim 10 wherein said second telephone device requires no prearrangement with said further commercial access provider node.

12. A communication arrangement for long distance telephone to telephone voice communication comprising

a first provider node of a digitized packet based network having means to allow users to initiate a telephone communication with a desired telephone device identified by a telephone address by the steps of

initially forming a communication with said first provider node and providing said telephone address thereto,

said first provider node cooperating with a second provider node of said digitized packet network to form a real time voice communication channel therebetween and said second provider node including dial out capabilities which are used upon receipt of the telephone address provided thereto to form a telephone communication with the telephone device,

said second provider cooperating with said first provider node to link the telephone devices using a digitized packet based network segment between said provider nodes and

using PSTN segments between the initiating telephone device and the first provider node and between the second commercial access provider node and said telephone device identified by said telephone address,

wherein the first and second provider nodes appropriately process the signals for transmission using the

digitized packet based network. [some paragraphing added by the parties]

14. A long distance telephone communication arrangement having three distinct communication segments, comprising

a first communication segment which carries voice communication over a PSTN between a first telephone device and a first commercial access provider node of a digitized racket based network

a second segment between said first commercial access provider node and a second commercial access provider node of said digitized packet based network which exchange digitized voice packets therebetween based on communications received from the first and third segments,

said third segment carrying voice communication over a PSTN between a second telephone device and said second commercial access provider node after said second commercial access provider node has established said third segment with said second telephone device, and

wherein said second commercial access provider establishes said third segment with said second telephone device by using the telephone address of said second telephone device provided thereto by said first provider which received the telephone address in a communication from said first telephone device. [paragraphing added by parties]

17. A long distance telephone communication arrangement as claimed in claim 14 wherein said first and second commercial access provider nodes convert the signals for transmission by the second segment to a different form relative to the signals carried by the first and third segments.

18. A long distance telephone communication arrangement having three distinct communication segments for transmitting a signal, comprising

a first communication segment which carries voice communication over a PSTN between a first telephone device and a first commercial access provider of a digitized packet based network,

a second segment between said first commercial access provider and a second commercial access provider of said digitized packet based network which exchange digitized voice packets therebetween based on communications received thereby, and

a third segment which carries voice communication over a PSTN between a second telephone device and said second commercial access provider and wherein said first and second commercial access providers convert the signal to and from the first and third segments whereby the signal carried by the second segment is in a form different from the signal carried by at least one of the first and third segments, and

wherein said second commercial access provider establishes said third segment with said second telephone device by using the telephone address of said second telephone device provided thereto by said first provider which received the telephone address in a communication from said first telephone device. [paragraphing added by parties]

eBay asserts that "Defendants sell numerous calling cards using systems and networks that are based on the very same VoIP [voice over internet protocol] architecture described and claimed in the '350 patent." (Doc.

No. 82 at 13). eBay says that the figure below was reproduced from a Net2Phone advertisement, and shows an implementation of "The Net2Phone Network."

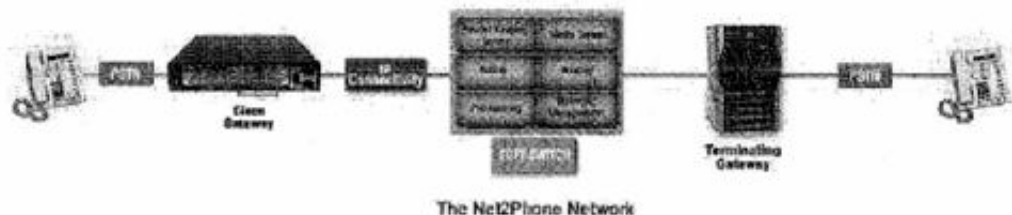

Id. eBay contends that the figure illustrates two telephones connected over the PSTN to "commercial access providing computer systems (shown in the figure as a Cisco Gateway and Terminating Gateway)." Id. at 14. eBay says that those computer systems "communicate with each other and transmit data over a data packet network labeled as 'IP [Internet Protocol] connectivity' in the figure." Id. eBay argues that "[t]his is the very same architecture described and claimed in the '350 patent." Id.

C. Agreed Terms

The parties agree that the following terms have the following meanings:

<i>Claim Term</i>	<i>Agreed Construction</i>
"telephone address"	A telephone number.
"communication arrangement having three distinct segments"	No construction needed. The claim term's ordinary meaning governs
"cooperating with"	No construction needed. The claim term's ordinary meaning governs
"located in closer proximity"	No construction needed. The claim term's ordinary meaning governs
"a predetermined arrangement"	An arrangement made before the communication.
"no prearrangement"	No arrangement made before the communication.

See Doc. No. 99 at 3-12 (JCCC, Exhibit 1 at 1-10)

Additionally, the parties agree that "communication channel" does not require construction. (Doc. No. 86 at 6). Further, the parties agree that the preambles of claims 1, 2, 5, 6, 9, 11, 14, 17, and 18 are limiting. (Doc. No. 82 at 16).

D. Disputed Terms and Phrases

1. "commercial access provider ... of INTERNET" or "of digitized packet based network"

Claim 1 (and its dependent claims) use the phrase "commercial access provider node of INTERNET," while the remainder of the asserted claims use the phrase "commercial access provider node of a digitized packet based network." The phrases "commercial access provider node" (and similar phrases), "node," and "digitized packet based network," however, are separately disputed. Accordingly, the parties have here focused on "commercial access provider." The parties agree that the phrase should receive the same construction, whether in claim 1 or the remainder of the asserted claims.

The phrase appears in claim 1 as follows:

1. A method of forming a long distance communication channel between two telephone devices each of which are connected to a PSTN, said method comprising

a user of one of said telephone devices initiating and establishing a telephone communication with a first **commercial access provider** node of INTERNET and providing thereto a telephone address,

using INTERNET to establish a communication channel between said first **commercial access provider** node and a second **commercial access provider** node of INTERNET and providing said telephone address to said second **commercial access provider** node,

said second **commercial access provider** node using said telephone address and a telephone dial out capability of said second **commercial access provider** node to establish a communication with a telephone device at the telephone address using a PSTN, and

using the INTERNET communication channel to link said telephone devices and form a real time voice communication between said telephone devices. (emphasis added)

a) The Parties' Proposed Constructions

The parties propose the following constructions:

<i>eBay</i>	<i>IDT</i>
A computer system commercially available to telephone users that acts to provide an interface to or from the Internet.	A service provider that provides subscription-based services and uses a computer system commercially available to telephone users that acts to provide an interface to or from the Internet.
A computer system commercially available to telephone users that acts to provide an interface to or from a digitized packet based network.	A service provider that provides subscription-based services and uses a computer system commercially available to telephone users that acts to provide an interface to or from a digitized packet based network.

See Doc. No. 99 at 13 (JCCC, Exhibit 1 at 11).

In its opening brief, eBay urged that a "commercial access provider" is (1) a computer system, (2) that is commercially available to telephone users, and (3) provides an interface to or from the Internet or a digitized packet based network. (Doc. No. 82 at 16-20). eBay criticized IDT's then-proposed construction as (1) having no basis in the claim language, and (2) being inconsistent." *Id.* at 16-19. IDT thereafter revised its proposed construction adopting that portion of eBay's proposed construction calling for "commercially available to telephone users that acts to provide an interface to or from the Internet" (or a digitized packet based network). Thus, the core of the dispute is whether "commercial access provider" in the context of the claims and the '350 patent would mean to one of ordinary skill in the art (1) a "computer system" as eBay contends, or (2) a "service provider that provides subscription-based services and uses a computer system" as IDT contends. IDT contends that a "commercial service provider" (1) uses a computer system to provide access to the Internet or a digitized packet based network, and (2) provides a subscription-based service. (Doc. No. 86 at 9-11).

b) Discussion

(1) The Claims

Beginning as always with the words of the claim-and using claim 1 as representative-the claim language *per se* offers some, but not much, assistance in resolving the current dispute. Beginning with the preamble, which the parties agree is limiting, claim 1 is drawn to a method "of forming a long distance communication channel between two telephone devices each of which are connected to a PSTN." The first step provides:

a user of one of said telephone devices initiating and establishing a telephone communication with a first commercial access provider node of INTERNET and providing thereto a telephone address,

Quite simply, a "user" initiates and establishes a telephone communication with a "first commercial access provider node" and provides a "telephone address" which the parties agree means a telephone number. The term "user" *per se* does not on its face require a subscription, or a contractual or similar relationship between the "user" and the "first commercial access provider." The term "node" (which again is a separately disputed term) may suggest a computer network type of connection, but that does not necessarily mean that the "commercial access provider" (1) *is* a computer system, or, on the other hand, (2) means a service provider that "uses a computer system." Either could provide a "node."

The second step:

using INTERNET to establish a communication channel between said first commercial access provider node and a second commercial access provider node of INTERNET and providing said telephone address to said second commercial access provider node,

similarly may suggest a computer network type of connection, but again does not necessarily mean that the "commercial access provider" (1) *is* a computer system, or (2) means a service provider that "uses a computer system."

The third step:

said second commercial access provider node using said telephone address and a telephone dial out capability of said second commercial access provider node to establish a communication with a telephone device at the telephone address using a PSTN, and

likewise may suggest a computer network type of connection, but yet again does not require that the "commercial access provider" (1) *is* a computer system, or (2) means a service provider that "uses a computer system."

The fourth step:

using the INTERNET communication channel to link said telephone devices and form a real time voice communication between said telephone devices.

also does not resolve the dispute. The claim *does* call for "a real time voice communication between said telephone devices," and the preamble, once again, calls for "forming a long distance communication channel

between two telephone devices each of which are connected to a PSTN." That suggests claim 1 is drawn to "a real time voice communication" between two telephones.FN8 Independent claims 8, 10 and 12 contain similar language (claim 8 "causing a real time voice communication channel to be formed between said telephone devices," claim 10 "forming a real time voice communication between said telephone devices," claim 12 "to form a real time voice communication channel therebetween."). But once again, that does not require that the "commercial access provider" (1) *is* a computer system, or (2) means a service provider that "uses a computer system."

FN8. The term "telephone device" is not a disputed term and both parties appear to regard the term as meaning a conventional "telephone" capable of connecting to a PSTN.

(2) The Specification

(a) Generic Internet Commercial Access Provider

Turning then to the specification, as noted briefly above, the specification under the heading "Background of the Invention" explains:

INTERNET(TM) now provides a network where a subscriber typically contracts with a commercial access provider (CAP) and obtains an Internet address as well as the capability to send and receive E-Mail on Internet and perform other functions which Internet supports. The subscriber typically uses his personal computer and modem to contact the commercial access provider using the public switched telephone network (PSTN), and once connected to Internet, performs the desired functions. The CAP provides an E-Mail box for the subscriber and the subscriber, when connected to the CAP, can review the contents of this electronic mailbox.

'350 patent, col. 1, lines 21-32. Thus, the patentee explains by way of background that typically a "subscriber" would "contract" with a "commercial access provider (CAP)" and obtain an Internet address and the capability to send and receive e-mail.FN9 The patentee notably does not say in that typical scenario that a "subscriber" is assigned a "telephone address" or "telephone number."

FN9. Although not addressed by the parties, an "Internet address" typically refers to an identification of a particular computer on the Internet, *see e.g.*, http://en.wikipedia.org/wiki/Internet_address, <http://browsers.about.com/od/webbrowserglossary/g/internetaddress.htm>, while an e-mail address typically consists of a unique identifier for a person (*e.g.*, a name), followed by "@" and a domain name, *see e.g.*, http://www.webopedia.com/TERM/E/e_mail_address.html, although sometimes "Internet address" can refer to the e-mail address as well. *See e.g.*, http://www.webopedia.com/TERM/I/Internet_address.html.

Drawing Figs. 1-3 of the '350 patent also illustrates a computer 22 connected through PSTN 10 and a "Generic Internet Access Provider" 8 to the Internet 4:

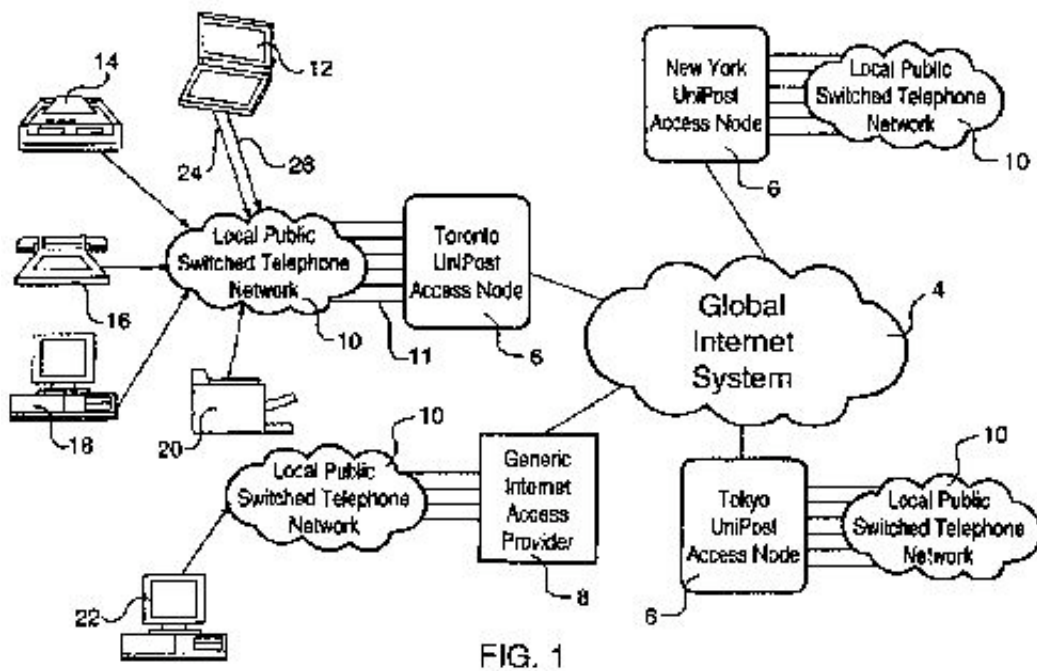

FIG. 1

FIG. 1

The specification explains that the "Internet has a number of Internet commercial access providers (CAPs) 8 which each have a host of subscribers who then have access to the various services of [the] Internet typically using their personal computers. The conventional Internet access provider would provide each subscriber with an Internet address and password number for retrieval of E-Mail." '350 patent, col. 5, lines 19-25. The specification goes on to explain that one using computer 22 may, for example, therefore send an e-mail message to "subscriber 'gordon@toronto.UniPost.com' " at 12.

The specification's explanation by way of background that a "subscriber typically contracts with a commercial access provider (CAP)" suggests that a "commercial access provider" in that context refers to an entity that may use computers and computer systems to provide access to the Internet and e-mail services, but is not a "computer system" *per se*—one does not typically "contract" with a computer (although computers may be "used" in forming contracts, *e.g.*, clicking "I Agree" to an agreement specifying terms of service/access). Also, that explanation suggests "commercial access providers" provide a subscription service. But, of course, the patentee's foregoing explanation relates to background and the prior art—not necessarily the invention of the '350 patent.

(b) Parties Arguments and Remainder of Specification

Turning then to the parties' arguments and the remainder of the specification, eBay argues that the specification expressly describes a "commercial access provider" as "computer system" pointing to the following first line from the "Summary of the Invention":

A messaging system according to the present invention having a bank of direct-in-dial (DID) telephone lines associated with a public switched telephone network and *a computer system which also acts as a commercial access provider for the Internet or other data communication networks* through which digital messages can be delivered. (emphasis by eBay)

'350 patent, col. 2, lines 6-12.FN10 (Doc. No. 82 at 17). But, "a computer system" that " *acts* as a commercial access provider" does not necessarily mean that a "commercial access provider" in the context of the invention of the ' 350 patent *is* a computer system-as opposed to a service provider that "uses a computer system."

FN10. eBay's brief cites to "'350 patent, col. 2: 6-33," however, the quoted material appears at lines 6-12.

The next sentence in the specification, for example (which also has a bearing on the second question, *i.e.*, the "subscription" question), which eBay does not quote, explains that "[t]he computer system provides each *subscriber* with an E-mail address and account for the data communication network, as well as a fax telephone address and a voice mail telephone address, where a communication addressed to any of the addresses results in the computer system receiving and storing the particular message in an electronic messaging mailbox for retrieval by the respective subscriber." '350 patent, col. 2, lines 12-19 (emphasis added). Although a "computer system" may be used to automate the process by providing (1) an e-mail account, (2) an account, (3) fax telephone address (telephone number), and (4) voice mail telephone address (telephone number), the term "subscriber" suggests something more than simply a "computer system" *per se*.

IDT also notes that the Summary of the Invention "later clarifies that a [*sic*] the commercial access provider is not a computer system, but uses a computer system," (Doc. No. 86 at 9), pointing to col. 3, lines 44-49, which explain: "The invention is also directed to a method of transmitting of voice, E-Mail and facsimile messages destined for a particular identified subscriber, which messages are *received by a computer system of a commercial access provider* connected to a data communication network through which E-Mail is transported" (emphasis by IDT).

eBay urges that further support for its argument that a "commercial access provider" *is* a "computer system" appears in the specification at col. 2, lines 19, 26, and col. 3, lines 49 and 59. (Doc. No. 82 at 17). Although eBay cites only to lines 19 and 26, the portion of the specification in column 2 that eBay relies on explains in context as follows:

The computer system is accessible to any subscriber using the public switched telephone network and/or the data network for retrieval of communications stored on behalf of the subscriber or a summary of the communications whereby the subscribers may contact a single automated source for retrieval of voice mail, E-mail, data files, or facsimile transmissions received on its behalf by the computer system.

'350 patent, col. 2, lines 19-26. eBay relies on the reference to "computer system." However, the specification also explains that the "computer system" is "accessible to any *subscriber*." In context, the specification is also referring to "retrieval of communications." The specification does *not* say that the "computer system" is accessible to "anyone" - *i.e.*, to someone who is not a "subscriber"-for *retrieval* of communications.

According to the specification, the "system" *is*, however, available to "anyone" wishing to leave messages "for the subscriber." For example, the very next two sentences in the specification explain:

Similarly, the system is accessible to *anyone wishing to leave a voice, facsimile, or other message for the*

subscriber by dialing the telephone number associated with the subscriber's electronic message mailbox. As a result, data networks, such as Internet, are accessible by devices other than computers, namely by telephones and facsimile terminals.

'350 patent, col. 2, lines 26-33 (emphasis added). That is, one wishing to leave messages "for the subscriber" need not themselves be "subscribers," but rather need only use "the telephone number associated with the subscriber's electronic message mailbox." Again, in the preceding portion of the same paragraph, the specification explains that "[t]he computer system provides each subscriber with an E-mail address and account for the data communication network, *as well as a fax telephone address and a voice mail telephone address*, where a communication addressed to any of the addresses results in the computer system receiving and storing the particular message in an electronic messaging mailbox for retrieval by the respective subscriber." '350 patent, col. 2, lines 12-19 (emphasis added). The specification does *not* say that the system provides "anyone" with an e-mail address, account *etc.*-that is reserved for "subscribers."

The portion of the specification in column 3 that eBay points to, although again eBay cites only to lines 49 and 59 (the portions eBay cites to are highlighted below), explains in context:

The invention is also directed to a method of transmitting of voice, E-Mail and facsimile messages destined for a particular identified subscriber, which messages are received by a computer system of a commercial access provider connected to a data communication network through which E-Mail is transported. *The computer system* is also connected to a public switched telephone network by means of which facsimile transmissions and voice transmissions are received and transmitted, and wherein a subscriber may access the computer for retrieval of messages stored in his electronic message mailbox or, his behalf. The retrieval of messages can use the public switched telephone network and the data communication network directly connected to access the subscriber's electronic message mailbox or retrieval can use the public switched telephone network to form a direct connection with *the computer system* for retrieval of messages. This method provides the subscriber with a number of alternatives for accessing his particular electronic message mailbox including using the data communication network to access his mailbox when this is the most desirable or cost effective manner to retrieve the communications. (emphasis added)

'350 patent, col. 3, lines 44-65. That is, the "computer system" is connected to the PSTN which allows a "subscriber" to retrieve voice, e-mail and fax messages using several alternatives. But again, that does not mean that the "commercial access provider" *is* a "computer system," as opposed to a service provider that "uses a computer system." And, once again, the specification refers to the fact that "a *subscriber* may access the computer" which suggests the "commercial access provider" is more than a "computer system" *per se*.

eBay further argues that the disclosure of "UniPost Access Nodes," which eBay says are "specialized access computers," (Doc. No. 82 at 17)(citing col. 4, lines 30-34), and that the specification "repeatedly refers to this system as including 'commercial access providing *computers*,'" (eBay's emphasis), *id.*, (citing col. 2, lines 6-11, 44-51, 54 and 65, and col. 3, lines 3-4, 11, 17-38, 40 and 49), support construing "commercial access provider" as a "computer system." In particular, eBay relies on the following quote from the specification:

According to yet a further aspect of the invention the communication system includes at least two *commercial access providing computers*, each interconnected to the Internet, and wherein the subscribers to the system can access either of the two *commercial access providing computers* for retrieval of communications stored on behalf of the subscriber. Information is effectively exchanged between the two

commercial access providing computers when necessary to allow retrieval of the information by the subscriber by accessing either of the computers. This effective communication between the computers using the Internet, allows a fast, reliable and cost-effective transfer of information. Such a system has the benefit of providing the subscriber with access to the closest *commercial access providing computer* and can reduce long distance charges as well as improve the quality of the communication channel, as typically a local or shorter long distance call is required to connect with the particular *commercial access providing computer*.

(Doc. No. 82 at 17-18)(citing '350 patent, col. 3, lines 17-38) (emphasis by eBay). eBay argues that the "fact that a 'commercial access provider' includes 'commercial access providing computers' further underscores the fact that a 'commercial access provider' is a computer system." (Doc. No. 82 at 18). But "commercial access providing computers" in the context of the foregoing simply means that "computers" are providing "commercial access" to the Internet for "subscribers" such that "subscribers" can retrieve communications. That does not mean that a "commercial access provider" is a "computer system" *per se*, as opposed to a service provider that uses a computer system.

Indeed, the specification uses "UniPost" to refer to a "new type of commercial access provider of the type associated with the Internet." The specification explains:

The term "UniPost" will be used to describe a new type of commercial access provider of the type associated with Internet. UNIPOST(TM) provides dial-in access to its subscribers through specialized access computers called UniPost Access Nodes (UANs) located in different geographical regions (see FIG. 1). Each UniPost Access Node provides a subscriber with an E-Mail address and account, preferably an Internet address, for example:

`jsmith@acmefireworks.com`

This address provides access to the subscriber for other Internet subscribers, and for subscribers to services that have gateways into Internet. In addition, the subscriber is provided with a Personal Mailbox Telephone Number, for example: 1-416-555-1234, and Personal ID Number (PIN): 63265. Therefore, a UniPost subscriber may be provided with the following:

Internet Address: `gordon@toronto.unipost.com`

Personal Mailbox Number: 1-416-555-1234

Personal ID Number or password: 63265

The UniPost Access Node provides the subscriber with access to all normal facilities of Internet, including E-Mail, databases, conferences, and forums. The UniPost Personal Mailbox Number provides the subscriber with an access point which can receive messages from terminals other than computers, specifically from telephones and facsimile machines. Thus, his Personal Mailbox Number allows for receipt of voice and facsimile messages.

'350 patent, col. 4, lines 30-58. As noted above, the patentee explained by way of background that prior to the invention of the '350 patent, "a subscriber typically contracts with a commercial access provider (CAP) and obtains an Internet address as well as the capability to send and receive E-Mail on Internet" and the "CAP provides an E-Mail box for the subscriber and the subscriber, when connected to the CAP, can review

the contents of this electronic mailbox." '350 patent, col. 1, lines 21-32. The "new type of commercial access provider" described in the specification, like the "typical" commercial access provider, provides a "subscriber" with an e-mail address and an account. However, the "new type of commercial access provider" also provides the "subscriber" with a "Personal Mailbox Telephone Number." Thus others can not only send e-mails to the "subscriber" in the same way as in the prior art, but can additionally send the "subscriber" voice and facsimile messages.

Recall, as the Court noted earlier in briefly summarizing the disclosure of the '350 patent, that the patentee explained "E-Mail systems have been available for many years and although they provide a very cost effective alternative to facsimile transmissions, the popularity of E-Mail does not nearly approach the popularity of voice and facsimile messaging and the number of users is many times lower." '350 patent, col. 1, lines 38-42. The invention of the '350 patent, by providing "subscribers" with a "Personal Mailbox Telephone Number" addressed the problem the patentee perceived- *i.e.*, now, in addition to e-mails, others could use telephones and fax machines to leave voice mail and fax messages for a "subscriber" by using the subscriber's "Personal Mailbox Telephone Number."

The specification, for example, further explains that with an e-mail address and a "Personal Mailbox Telephone Number" subscribers may be contacted, not only by e-mail users, but "the hundreds of millions of telephone and facsimile devices now in use":

With this arrangement, the subscriber can be contacted by the millions of PC users in the world familiar with E-mail, as well as the hundreds of millions of telephone and facsimile devices now in use. Furthermore, the various received communications are received by a centralized system and can be retrieved by the subscriber his or her convenience.

'350 patent, col. 4, lines 58-62.

Also, the specification explains that message retrieval is facilitated because it was contemplated that UniPost Access Nodes would be distributed throughout the world:

The fact that the various UniPost Access Nodes are distributed throughout various countries and the world and connected by the Internet or another commonly available data communication network makes retrieval of messages more effective.

'350 patent, col. 4, line 64-col. 5, line 1.

The specification also explains that the UniPost Access Nodes can include provisions for converting e-mail to facsimile transmissions (or *vice versa*) or to speech, thus further facilitating retrieval by "subscribers":

Furthermore, each UniPost Access Node can include arrangements for converting of various communications from one form to another making retrieval easier and more flexible. For example, a *subscriber* may not wish to actually receive E-Mail as E-Mail, but may wish to have an E-Mail address. When a communication is address[ed] to him using the E-Mail address, the UniPost Access Node may convert it to a facsimile transmission and send it out to the *subscriber* as a facsimile transmission. In this way, the *subscriber* need not have the capability of receiving all transmissions and can use certain features of the UniPost Access Nodes for conversion of communications received in one form to another form. The UniPost access mode can also provide conversion of facsimile transmissions to E-mail, or E-Mail to speech.

In this way, *subscribers* need not have their own conversion hardware and/or software.

'350 patent, col. 5, lines 2-16 (emphasis added). The context suggests those services are offered through the use of a "computer system," but it is equally clear those features are offered to "subscribers."

(3) E-Mail, Voice and Facsimile Messages

From the foregoing—as well as the specification and drawings as a whole, and eBay's arguments—a fundamental feature of the '350 patent is using the Internet (or a digitized packet based network) to allow sending and retrieval of not only e-mail messages, but voice and facsimile messages as well. In each of those instances, there is (1) an originator of a message or communication, and (2) a recipient.

(a) E-Mail Messages

Turning first to e-mail communications, it seems clear that both the originator and recipient must have (1) access to the Internet (or a digitized packet based network), and (2) an e-mail address. In the prior art described in the specification, both were provided when "a subscriber typically contracts with a commercial access provider (CAP)." As noted above, the UniPost commercial access provider does the same ("The term 'UniPost' will be used to describe a new type of commercial access provider of the type associated with Internet," "UNIPOST provides dial-in access to its subscribers ...," "Each UniPost Access Node provides a subscriber with an E-Mail address and account ...," "The UniPost Access Node provides the subscriber with access to all normal facilities of Internet, including E-Mail, databases, conferences, and forums.").

In the case of e-mail communications, the specification draws a distinction between "UniPost," used "to describe a new type of commercial access provider" and "Internet commercial access providers (CAPs) 8," '350 patent, col. 5, lines 19-20, which are labeled on the drawings as "Generic Internet Access Providers." In connection with Fig. 1, the specification explains that the "Internet 4" "has a number of Internet commercial access providers (CAPs) 8 which each have a host of subscribers who then have access to the various services of Internet typically using their personal computers. The conventional Internet access provider would provide each subscriber with an Internet address and password number for retrieval of E-Mail":

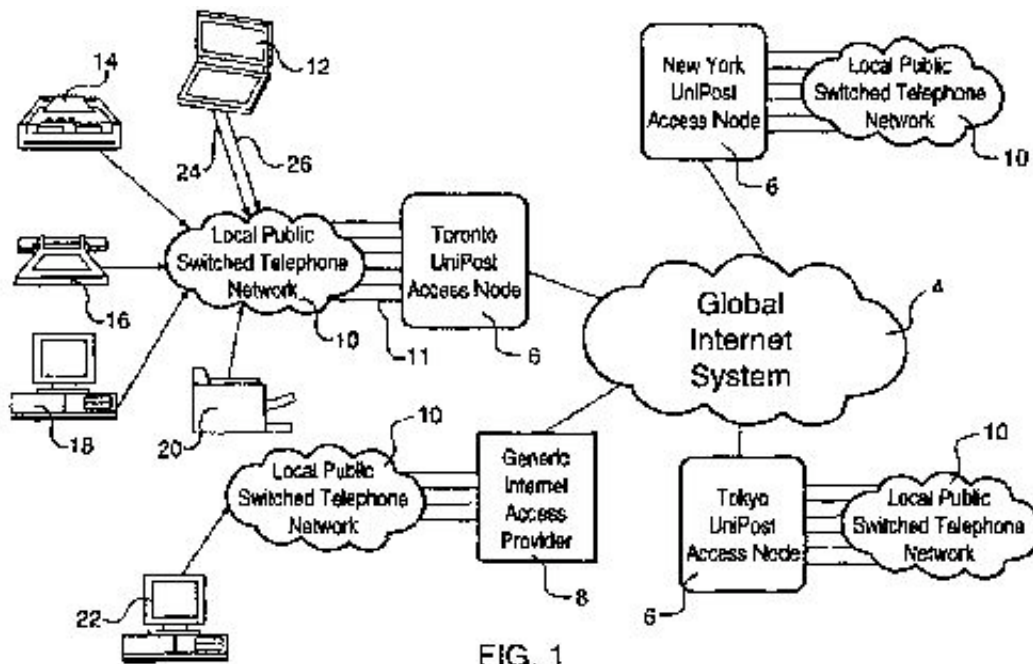

FIG. 1

FIG. 1

According to the specification, "[o]ne such subscriber 22 is shown using the local public switched telephone network 10 to gain access to the generic Internet CAP for transferring a file to E-Mail subscriber 'gordon @toronto.UniPost.com' indicated as 12. This is via the Toronto UniPost Access Node 6, which includes the electronic Mailbox of Gordon." '350 patent, col. 5, lines 17-30. Gordon can then retrieve the e-mail from UniPost Access Node 6 as indicated by line 24. '350 patent, col. 5, lines 30-33. Thus, in the case of e-mail messages, the specification refers to both the originator of the e-mail 22, and the recipient 12, as "subscribers" presumably because both require a "commercial access provider" to provide (1) access to the Internet (or a digitized packet based network), and (2) an e-mail address.

(b) Voice and Facsimile Messages

In the case of voice and facsimile communications, however, the situation is different. Unlike the "generic Internet CAP," the UniPost commercial access provider additionally provides a "subscriber" with a Personal Mailbox Telephone Number which allows at least two functions not available from a "generic Internet CAP," namely the Personal Mailbox Number (1) allows others to send voice and facsimile messages to a subscriber, and (2) "provides the subscriber with an access point which can receive messages from terminals other than computers, specifically from telephones and facsimile machines." '350 patent, col. 4, lines 53-57.

Specifically, in the case of voice and facsimile message, the specification explains in connection with Fig. 1 that "[m]essages to the UniPost Internet subscriber 12 can also be made from a facsimile machine 14, from a telephone set 16, from a computer modem connection indicated as 18, or a message via Binary File transfer (BFT) indicated by the apparatus 20," '350 patent, col. 5, lines 37-41, through a local PSTN 10. The specification explains that "[t]hus, to a caller calling a UniPost subscriber from a telephone, the UAN will behave like a voice mail system. For callers calling a UniPost subscriber from a facsimile machine, the UAN will behave like a receiving facsimile machine." '350 patent, col. 6, lines 9-12.

The patent further explains that "the communications can be accessed by the UniPost Internet subscriber 12 making contact with the Toronto UniPost Access Node 6 or any other UAN worldwide and retrieving of communications that have been received for the subscriber." '350 patent, col. 5, lines 51-55. In particular, in Fig. 2 "each subscriber with a separate electronic message mailbox, generally shown as 30," is provided with "a facsimile in-box 32, a voice in-box 34, an E-Mail box 36 and a facsimile out-box 38." '350 patent, col. 6, lines 41-44. According to the specification, a "subscriber" may retrieve e-mail, voice and fax messages using a computer and modem 12. '350 patent, col. 6, lines 51-63:

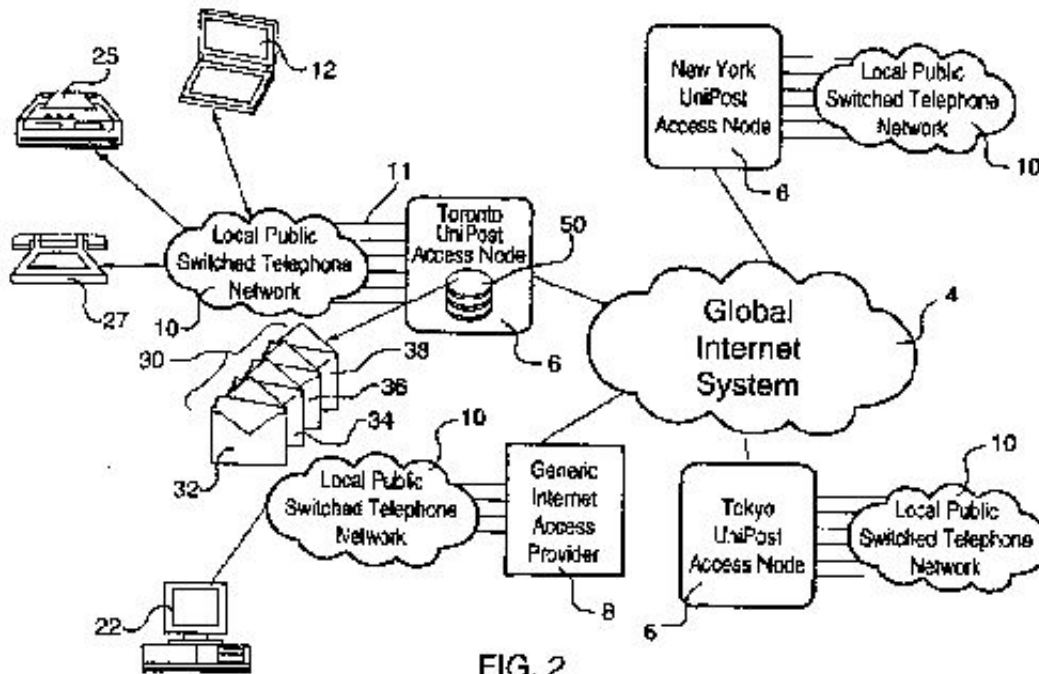

FIG. 2

FIG. 2

Alternatively, the specification explains, a "subscriber" may use a facsimile machine 25 or telephone 27 to retrieve messages. The specification further describes the steps for doing so: "if the subscriber is at the facsimile machine 25 and wishes to retrieve messages, he can contact the Toronto UniPost Access Node 6, key in his particular password, and direct the UniPost Access Node to send the facsimile message to the machine preferably directly without forming a further communication. On the other hand, the subscriber could use the telephone set 27 to get a summary of messages received as well as any voice messages, and then direct the Toronto UniPost Access Node 6 to send E-Mail or facsimile messages to the facsimile machine 25." '350 patent, col. 6, line 64 -col. 7, line 8.

In the embodiments of Figs. 1 and 2, it therefore seems clear that anyone having a telephone or facsimile machine is able to leave voice and fax messages for a "subscriber." In that instance, the originator of the message need not be a "subscriber." However, it also seems clear from the specification of the '350 patent that the recipient of such messages must be a "subscriber."

That conclusion is further supported by the claims of the parent '786 patent which similarly provide that the

recipient is a "subscriber." For example, claim 1 of the parent '786 patent provides:

1. A communication system comprising a plurality of commercial access providing computers where each commercial access providing computer is associated with INTERNET *to allow subscribers to use the services* offered by INTERNET, said communication system having many registered subscribers who are collectively unrelated and each subscriber is associated with one of said commercial access providing computers, providing each subscriber with an E-mail address for INTERNET, a fax address telephone address and a voice mail telephone address, where a message addressed to any of the addresses results in said associated commercial access providing computer receiving and storing the addressed message *for retrieval by the respective subscriber*, said commercial access providing computers *allowing each subscriber to access and retrieve messages* stored on his behalf or a summary of messages stored on his behalf by using either a telephone set which forms a telephone communication with said associated commercial access providing computer or using a computer and modem which forms a telephone communication with one of said commercial access providing computers, and wherein said plurality of commercial access providing computers use INTERNET to exchange information therebetween, and *wherein subscribers of the system* can access any of said commercial access providing computers for retrieval of messages stored on behalf of a subscriber, said commercial access providing computers cooperating such that *messages stored for a subscriber* in said associated computer are transferred using INTERNET from said associated access providing computer to one of the other commercial access providing computers which has been contacted by the subscriber for retrieval of communications stored on his behalf. (emphasis added)

(Doc. No. 82-5 at 13) ('786 patent, col. 11, lines 26-57).

Claim 9 of the 786 patent similarly provides:

9. A method of receiving voice, E-mail, and facsimile messages *addressed to a subscriber* which messages are received by a computer system connected to a data communication network through which E-mail is received and transmitted and wherein the computer system has a plurality of commercial access providing computers interconnected by said high speed data communication network, each commercial access providing computer including many direct in dial telephone lines connected to a public switched telephone network by means of which facsimile messages and voice messages are received and transmitted, and wherein *any of the subscribers may retrieve messages* stored on his behalf using said public switched telephone network and said data communication network directly associated with said computer system or using said public switched telephone network to form a direct connection with any of said commercial access providing computers of said computer system for retrieval of messages with said computers communicating the messages therebetween through said data communication network. (emphasis added)

Id. ('786 patent, col. 12, lines 29-48).

Claim 11 of the '786 patent likewise provides:

11. A unified messaging system comprising a computer system having a plurality of commercial access providing computers interconnected by a high speed data communication network for digital data transmission, each commercial access providing computer including a bank of direct in dial telephone lines associated with a public switched telephone network and acting as a commercial access provider for said high speed data communication network through which E-mail is delivered, said computer system providing

each subscriber with an E-mail address for data communication access, a fax telephone address and a voice mail telephone address, where a message addressed to any of the addresses results in the computer system receiving and storing the addressed message *for retrieval by the respective subscriber, said computer system being accessible to any subscriber* using said public switched telephone network and/or said high speed data network *for retrieval of messages stored on behalf of said subscriber* or a summary of said messages whereby said subscribers may contact any of said commercial access providing computers for of voice mail. E-mail or facsimile messages received on its behalf by said computer system which messages, if necessary, are exchanged between any of said commercial access providing computers over the data communication network. (emphasis added)

Id. at 13-14 ('786 patent, col. 12, line 58 col. 13, line 14).

In addition, there is no disclosed embodiment in which a "non-subscriber" may leave voice mail or facsimile messages for another "non-subscriber." Although that is not necessarily dispositive, it is a factor to consider.

eBay argues that "[t]he fact that the patentee expressly included a 'subscriber' limitation in the claims of the '786 patent but did *not* include such a limitation in the claims of the child '350 patent provides additional compelling support against importing a 'subscriber' limitation into the claims of the '350 patent." (Doc. No. 82 at 22) (emphasis by eBay). Perhaps. The point, though, is not "importing a 'subscriber' limitation into the claims," but rather attempting to get a sense for how one of ordinary skill in the art would construe "commercial access provider." "The inquiry into how a person of ordinary skill in the art understands a claim term provides an objective baseline from which to begin claim interpretation." Phillips, 415 F.3d at 1313. However, "[i]mportantly, the person of ordinary skill in the art is deemed to read the claim term not only in the context of the particular claim in which the disputed term appears, but in the context of the entire patent, including the specification." *Id.* "[T]he line between construing terms and importing limitations can be discerned with reasonable certainty and predictability if the court's focus remains on understanding how a person of ordinary skill in the art would understand the claim terms ." *Id.* at 1323. After all, "[u]ltimately, the interpretation to be given a term can only be determined and confirmed with a full understanding of what the inventors actually invented and intended to envelop with the claim. The construction that stays true to the claim language and most naturally aligns with the patent's description of the invention will be, in the end, the correct construction." *Id.* at 1316, quoting *Renishaw PLC v. Marposs Societa' per Azioni*, 158 F.3d 1243, 1250 (Fed.Cir.1998) (citations omitted). The claims of the parent '786 patent are certainly not dispositive, and not necessarily all that persuasive, but remain a factor that may be taken into account.

Fig. 2 illustrates retrieval by a "subscriber" from the Toronto UniPost Access Node using dial-in access. Fig. 3 illustrates how a "subscriber," '350 patent, col. 4, lines 17-20, may retrieve messages remotely using the Internet:

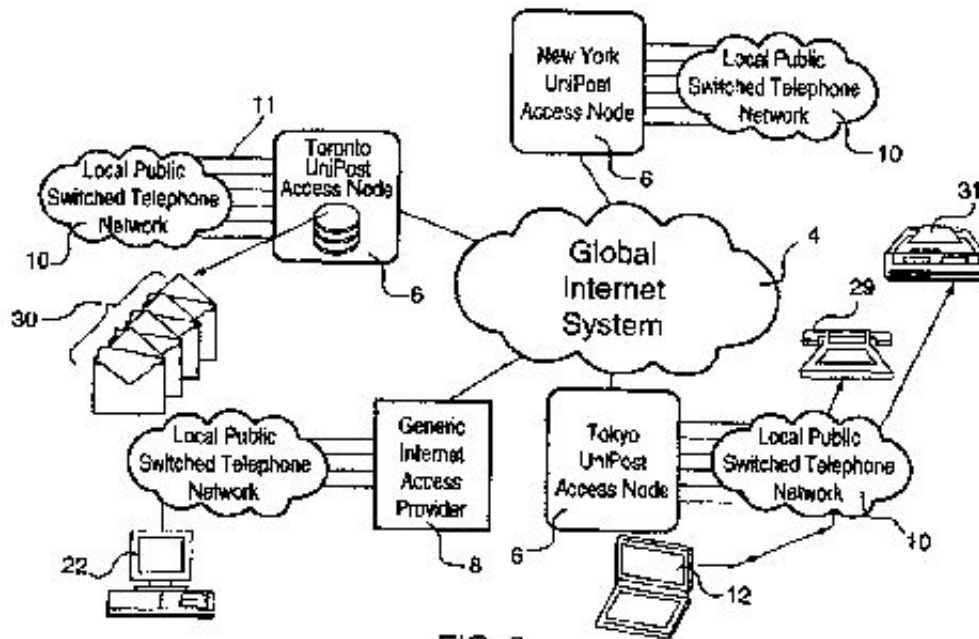

FIG. 3

FIG. 3

In this instance, the specification explains, "UniPost Internet subscriber, generally indicated as 12, is in Japan and uses the local public switched telephone network 10 to contact the Tokyo UniPost Access Node 6." Then, according to the specification, "[a]fter proper identification of the subscriber, the Tokyo UniPost Access Node uses Internet 4 to access the electronic mailbox 30 of the subscriber and allows retrieval of the various contents of the various boxes." A "subscriber" can then retrieve messages using a computer and modem 12, a telephone 29, or a facsimile machine 31. '350 patent, col. 7, lines 27-47. Doing so allows a "subscriber" to retrieve messages using the Internet and a local PSTN connection:

It can also be appreciated that the example shown in FIG. 3 has allowed the subscriber 12 to form a relatively local connection using the public switched telephone network 10 to contact the Tokyo UniPost Access Node 6. This is then connected to the Toronto UniPost Access Node 6 and the electronic mailbox of the subscriber via an Internet or dedicated data communication channel. Information is retrieved from the mailbox and provided to the UniPost Access Node, also by this data communication channel provided by Internet. In contrast to a single UniPost Access Node, the multiple access nodes, shown in FIG. 3, advantageously use the dedicated data communication network to interconnect the access nodes and reduces the need for long distance telephone communications with a particular computer.

'350 patent, col. 7, lines 47-61.

(c) The Embodiment of Fig. 4

The embodiment of Fig. 4, although also drawn to sending a facsimile message, is a bit different from Figs. 1-3. Once again, Fig. 4 is described as "an overview showing an effective manner for delivering a facsimile in a cost effective manner." '350 patent, col. 4, lines 21-22.

In this embodiment, facsimile machine 60 is illustrated as connected to PSTN 10 which in turn is shown as

having connections to Toronto UniPost Access Node 6. Also, facsimile machine 62 is illustrated as connected to PSTN 10 which in turn is shown as having connections to Tokyo UniPost Access Node 6. Thus, this portion of the illustration is the same as for facsimile machine 14 in Fig. 1, and facsimile machine 31 in Fig. 3. In Fig. 1, a "non-subscriber" may use a "subscriber's" Personal Mailbox Telephone Number to leave a fax message on Toronto UniPost Access Node 6, which may then be retrieved by the "subscriber" remotely in Tokyo as illustrated in Fig. 3, and as discussed above. The difference from Figs. 1 and 3, according to the specification, is that "FIG. 4 shows how a facsimile transmission addressed to a particular address in Japan can effectively use the UniPost access system." '350 patent, col. 8, lines 7-9:

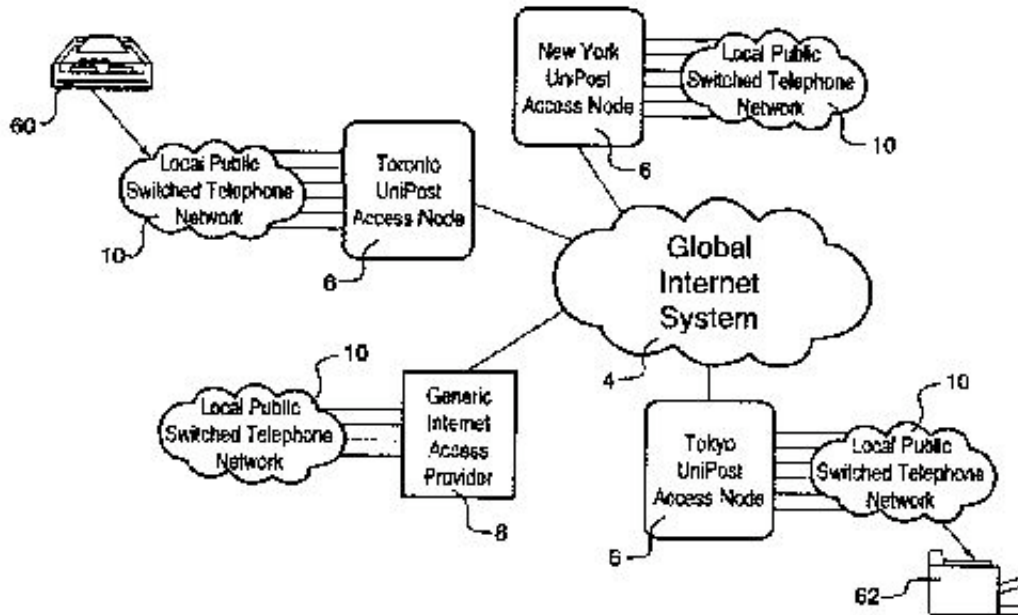

FIG. 4

FIG. 4

The specification first explains that "[i]n this case, the transmission is sent from the facsimile machine 60 via the public switched telephone network 10 to the UniPost Access Node 6." '350 patent, col. 8, lines 9-11. The specification *at this juncture* does not expressly say whether the "UniPost Access Node 6" is the one in Toronto or Tokyo. The next sentence, though, says "[t]he facsimile machine 60 can include add-on devices to cause *this long distance call* to be rerouted or the communication may first be made to the Toronto UniPost Access Node and thereafter to the Japanese address." '350 patent, col. 8, lines 11-15. Because Fig. 4 illustrates fax machine 60 connected through a *local* PSTN to Toronto UniPost Access Node 6, the reference to "this long distance call" suggests that "UniPost Access Node 6" refers to the Tokyo node. The specification does not describe the referenced "add-on devices." But whatever those devices are, according to the specification, they "cause *this long distance call* to be *rerouted* ..." to the Toronto UniPost Access Node and thereafter to the Tokyo UniPost Access Node. All of that suggests that a fax is being sent from fax machine 60 through the Toronto node to the Tokyo node and then to fax machine 62—as opposed to simply sending the fax to the Toronto node for later retrieval as illustrated in Figs. 1, 2 and 3.

How one does so is less clear. The specification, as noted above, says that "FIG. 4 shows how a facsimile transmission addressed to a particular address in Japan can effectively use the UniPost access system." '350

patent, col. 8, lines 7-9 (emphasis added). The emphasized phrase suggests that the user must have access to the UniPost system. Although, as discussed above, non-subscribers may leave voice mails and facsimile messages which may thereafter be retrieved by subscribers, there is no disclosure in the '350 patent of non-subscribers having the ability to otherwise "use" the UniPost access system. This portion of the specification thus suggests that in the embodiment of Fig. 4, the originator of the fax message is a "subscriber." Indeed, the next sentence in the specification says that "the user provides the *direction* to initiate the contact with the Toronto UniPost Access Node 6." '350 patent, col. 8, lines 16-17 (emphasis added). The specification does not say *here* what that "direction" is. But again, the preceding sentence says "[t]he facsimile machine 60 can include add-on devices to cause this long distance call to be rerouted or the communication may first be made to the Toronto UniPost Access Node and thereafter to the Japanese address." '350 patent, col. 8, lines 11-15. In any event, the fax is sent to the Tokyo UniPost Access Node and then to fax machine 62. '350 patent, col. 8, lines 17-29.

Although the specification does not at the foregoing juncture say what "direction" a user provides, later the specification refers to this fax transmission in analogizing long distance voice communication: "The discount long distance voice messaging requires that each UniPost Access Node is able to accept and digitize voice calls.... *As with long distance facsimile calls, the call originator will dial the local UniPost Access Node and enter his account and the number of the recipient.* The UniPost Access Node will establish a packet path between the originating UniPost Access Node and the destination UniPost Access Node closest to the recipient. The destination UniPost Access Node will then place a local call to the recipient and deliver the voice message." '350 patent, col. 9, lines 11-23. The reference to dialing the local UniPost Access Node and then entering an "account number" strongly suggests that the originator of the fax message in the embodiment of Fig. 4 must be a "subscriber."

Also, the disclosure strongly suggests that the originating and receiving "commercial access providers" must be UniPost Access Nodes-or at least have the capabilities of such Nodes. Although "generic" Internet access providers may have the capability to establish a packet path from an originating node to a destination node, there is no disclosure that "generic" Internet access providers have the ability to place a local call to a recipient and cause the fax to be delivered to fax machine 62. It is less clear whether the recipient must be a "subscriber."

(d) The Embodiment of Fig. 5

Once again, Fig. 5 is described in the '350 patent as "a schematic of how the system can be used to complete a voice communication channel to a telephone set in a distant geographical location." '350 patent, col. 4, lines 23-26:

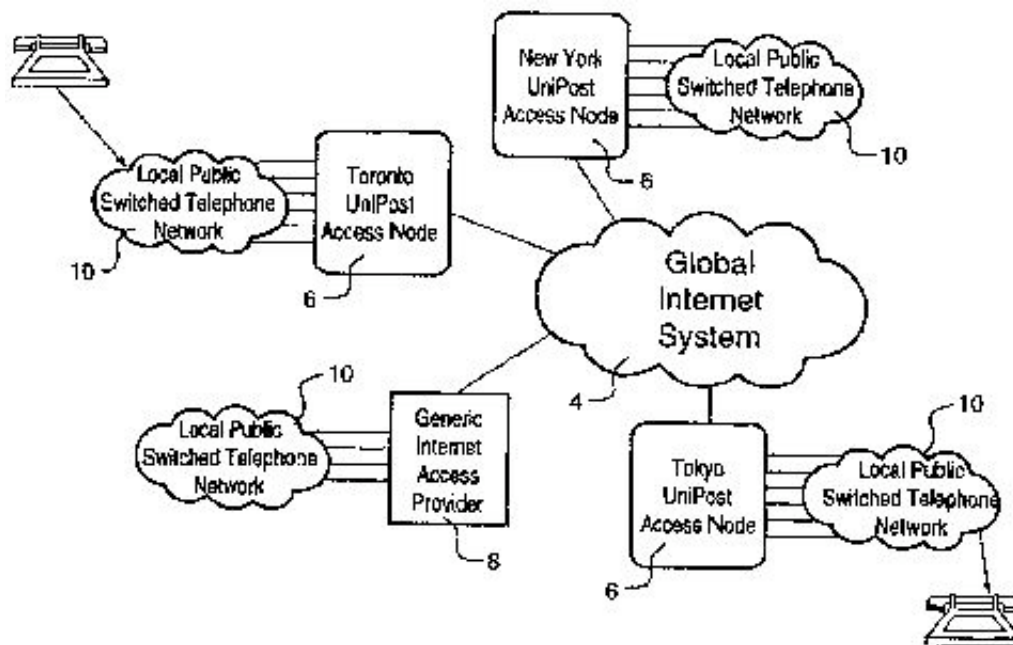

FIG. 5

FIG. 5

The specification contains scant disclosure of Fig. 5. The specification once again discloses that:

FIG. 5 also shows how this UniPost system can be used for providing a direct telephone link using the data transmission network involving Internet. In this case, voice is transmitted digitally and a live communication is maintained between Toronto UniPost Access Node 6 and Tokyo UniPost Access Node 6. Each of these have formed a live communication with the originating telephone set and the receiving telephone set. *This can thus provide the subscriber with a further cost advantage in completing his international communications or other long distance communications.*

'350 patent, col. 9, lines 1-10 (emphasis added). The specification thus says that a "subscriber" is provided with a cost advantage, suggesting once more that the originator of the telephone call must be a "subscriber." That is reinforced by the following disclosure, which is the same disclosure discussed above in connection with Fig. 4:

As with long distance facsimile calls, *the call originator will dial the local UniPost Access Node and enter his account and the number of the recipient.* The UniPost Access Node will establish a packet path between the originating UniPost Access Node and the destination UniPost Access Node closest to the recipient. The destination UniPost Access Node will then place a local call to the recipient and deliver the voice message.

'350 patent, col. 9, lines 16-23 (emphasis added). The emphasized language again strongly suggests that the call originator must be a "subscriber." Once again, the specification says that "the *subscriber* is provided with a ... Personal ID Number (PIN): 63265." '350 patent, col. 4, lines 42-45 (emphasis added).

Also, the specification discloses that "[t]he discount long distance voice messaging requires that each UniPost Access Node is able to accept and digitize voice calls," and as noted above, the destination access node places a local call to the recipient. That suggests that the originating and receiving nodes are UniPost

Access Nodes-or at least have the capabilities of such Nodes. There is no disclosure that "generic" Internet service providers have the ability to "accept and digitize voice calls" or make local phone calls in response to receiving a telephone number.

(4) eBay's "widely available" Arguments

eBay argues that the '350 patent discloses in the abstract that the system is "widely available" and provides "access to hundreds of millions of telephones," (Doc. No. 82 at 18) (citing col. 3, line 66-col. 4, line 4, and col. 4, lines 58-62). eBay urges that "[t]he millions of ordinary telephone users can continue using their existing telephones and yet still take advantage of the significant cost savings and efficiencies of the Internet-savings and efficiencies that are not available to conventional long distance calls routed through the PSTN." Id. eBay further cites to column 3, lines 35-38 disclosing that the "Internet becomes the transport backbone of a global voice and fax mail system and opens [the] Internet to transparent access by telephones, facsimile terminals and other non-subscriber devices," and col. 2, lines 30-33 that "[s]imilarly, the system is accessible to anyone wishing to leave a voice, facsimile, or other message for the subscriber by dialing the telephone number associated with the subscriber's electronic message mailbox. As a result, data networks, such as Internet, are accessible by devices other than computers, namely by telephones and facsimile terminals." (Doc. No. 82 at 18).

The portions of the specification that eBay cites to, however, relate to the messaging embodiments of Figs. 1-3. In those embodiments, as discussed above, non-subscribers using conventional telephone and fax machines may leave voice and fax messages for a subscriber which a subscriber can thereafter retrieve. In the embodiment of Fig. 5, on the other hand, a conventional telephone may be used to originate a call. However, as discussed above, the disclosure strongly suggests that the one originating a call must be a "subscriber."

(5) Prosecution History

eBay also cites to portions of the prosecution history in which eBay says that the "applicant repeatedly emphasized to the U.S. Patent and Trademark Office how the claimed invention, for the first time, opens up the efficiencies and cost benefits of the Internet to ordinary telephone users on a broad commercial basis." (Doc. No. 82 at 19). eBay makes similar arguments in its reply. (Doc. No. 91).

In actuality, during prosecution of the application maturing into the '350 patent, the applicant originally submitted a "Preliminary Amendment" dated June 4, 1996, that, *inter alia*, replaced the "Summary of the Invention" covering pages 2-6 of the specification. (Doc. No. 86-7 at 36). That new "Summary" included several paragraphs discussing "[a] method of establishing a long distance telephone communication between an initiating telephone device and a receiving device telephone ..." which were not in the original "Summary." Id. at 38. In an Office Action dated September 9, 1996, the PTO initially required, in light of the material added in the Preliminary Amendment, that the application be redesignated as a continuation-in-part (CIP), as opposed to a continuation. Id. at 52. In a response dated February 10, 1997, the applicant did not redesignate the application as a CIP. Id. at 65. In an Office Action dated March 4, 1998, the PTO, *inter alia*, objected to the Preliminary Amendment under 35 U.S.C. s. 132 as being drawn to new matter. The Office Action explained that "[a]s originally filed, the specification is directed to facsimile communications, there is no detailed description regarding long distance voice communications as added, such as using the telephone address to establish voice communications, the long distance [sic] comprising three distinct segments, *etc.*" The Office Action further provided that "Applicant is required to cancel the new matter in the reply to this Office Action." (Doc. No. 86-8 at 9).

The applicant responded on July 28, 1998, urging that Fig. 5 and the accompanying description provided support for the material added in the Preliminary Amendment, and the claims. The applicant argued that:

[1] The present invention allows long distance voice communications to be available to users of conventional telephones as the specialized protocols and procedures have been concentrated with the access nodes making the process simple and convenient and available to a huge number of telephone devices in a simple manner. [2] The prior art system discloses different arrangements for long distance voice communication over INTERNET but none of these systems make it available in the simple manner of the present invention where specialization and processing is resident at the commercial access provider nodes. This solution is in contradiction to the art and provides a new alternative to long distance real time voice communication. (brackets and numbers added)

In the next paragraph, the applicant argued that in the prior art "[t]he systems that are available for a normal telephone user require each user to have a computer and essentially, prearrange a telephone communication therebetween, *i.e.*, both systems have to be on line at the same time and this essentially requires each user to know of the desire to complete a telephone communication." *Id.* at 26.

eBay cites to the first sentence-sentence [1]-but does not refer to sentence [2] or the context of the prior art. (Doc. No. 82 at 19). In all events, this portion of the prosecution history does not assist eBay-in fact, quite the opposite. First, the applicant did *not* argue or assert that users were not required to be "subscribers." Second, the applicant *did* point out that "specialized protocols and procedures have been concentrated with the access nodes." The specification, yet again, which the applicant reproduces in its response, provides that "the *subscriber* " realizes a "cost advantage in completing his international communications or other long distance communications," and that "the call originator will dial the local UniPost Access Node and enter his account and the number of the recipient," (Doc. No. 86-8 at 25). The reason for dialing the UniPost Access Node and entering an account number, of course, is so that the user of a convention telephone can use the "specialized protocols and procedures" that have been "concentrated with the access nodes." In referring to making the process simpler, the prior art, as the applicant pointed out, required a computer, in addition to a telephone, and a prearrangement between the caller and the recipient.

The PTO was not convinced. In an Office Action dated September 4, 1998, the PTO again objected to the material added in the Preliminary Amendment, and required cancellation. In a response dated February 2, 1999, the applicant replaced the "Summary of the Invention" with the original content, *i.e.*, the specification was returned to what it had been *before* the Preliminary Amendment. The PTO subsequently entered a Notice of Allowance.

The applicant also submitted a Rule 132, 37 C.F.R. s. 1.132, declaration by Nuno Romao with the response of February 2, 1999, in arguing over certain rejections. eBay currently relies on statements made in that declaration. (Doc. No. 82 at 19). The first is in paragraph 3 of the Romao declaration, which states in full:

3. The present invention makes it possible to have conventional telephones communicate using PSTN's to interact with commercial access providers (CAPS) associated with a digital network to complete long distance real time voice communications. This approach allows conventional telephones to take advantage of this technology without requiring any special arrangement between the conventional phones. As such, this technology becomes generally available and is not limited to specialized networks as is the case in the art cited by the Examiner and attached to this affidavit."

(Doc. No. 82-7 at 14). eBay in its brief uses an ellipses after "generally available." (Doc. No. 82 at 19). In context, it is clear that when Romao referred to being "generally available," he was referring to the prior art that used "specialized networks." That does not address whether the call originator must be a "subscriber."

eBay also refers to a portion of paragraph 2 of Romao's declaration (which actually includes several unnumbered paragraphs). Again, the entire paragraph that eBay points to says:

The above digital technology [referring to the prior art in which voice was digitized and transmitted] is then combined with a commercial access provider to receive instructions *via* a local PSTN and a conventional telephone to complete a long distance call to a particular destination which instruction is sent to a second commercial access provider. This second commercial access provider out dials to the particular destination. The commercial access providers function like the local area network with respect to the signals provided thereto, and the local PSTN's complete the communication. This arrangement makes it possible for the multitude of existing conventional telephones to utilize the system in a very simple manner.

eBay quotes and emphasizes the last sentence. (Doc. No. 82 at 19). In context, though, it is clear that Romao was referring to the prior art, and, indeed, was responding to the PTO's rejection under s. 112(1) for lack of enablement. In context, Romao does not address whether the call originator must be a "subscriber."

(6) eBay-IDT's Proposed Construction Limits Claims to a Business

In its reply, eBay further contends that IDT's proposed construction limits the claims to a "business," which, eBay argues, is nowhere described in the intrinsic record, and becomes "nonsensical" in light of the claims. For example, eBay points to claim 18 providing that the first and second "commercial access providers" exchange voice communications data over a packet-based computer network and convert a signal into a different form. eBay urges that "[p]lainly, computer systems, not 'businesses,' are exchanging this data over the computer network." (Doc. No. 91 at 5). eBay further argues that with IDT's proposed construction, claim 18 would require two different businesses. *Id.*

IDT's proposed construction does not limit the claims to a "business." In all events, however, the '350 patent speaks in terms of a "subscriber" and in the prior art "a subscriber typically contracts with a commercial access provider (CAP)." Also, the '350 patent explains that a "subscriber" is given (1) an e-mail address, (2) an account number or password, and (3) a "Personal Mailbox Number." '350 patent, col. 4, lines 47-50. The point of being a "subscriber" is that only "subscribers" can retrieve messages from UniPost Access Nodes in the message embodiments of Figs. 1-3, and, by the most reasonable interpretation, only "subscribers" can make telephone calls using the Internet (or digitized packet based network) in the embodiment of Fig. 5 to which the asserted claims are drawn. In the context of the disclosure of the ' 350 patent, a "subscriber" is given entree to the features and capabilities of the UniPost Access Nodes-a "non-subscriber" is not.

As to eBay's second argument, IDT's proposed construction clearly "uses a computer system." Claim 18 is not rendered nonsensical. Such "computer systems" may communicate per the terms of claim 18.

(7) eBay-Use by Non-Subscribers

eBay, in its reply, also argues that IDT's proposed construction *vis-a-vis* "subscription-based services," is contradicted by the specification which, eBay, argues "explicitly teaches that the invention can be used by 'non-subscriber' devices." (Doc. No. 9 at 6-7).

eBay's citations to the specification are the same as those discussed above- *i.e.*, references to the messaging system of Figs. 1-3. As discussed above, in those embodiments, "non-subscriber" originators may leave voice and fax messages which a "subscriber" can thereafter retrieve. The asserted claims, however, as eBay points out in its opening brief, are drawn to the embodiment of Fig. 5. (Doc. No. 82 at 10). Further, in describing the embodiment of Fig. 5, eBay says that "[s]uppose Alice, who is now back in Toronto, wishes to call Bob in Tokyo. Alice places a local call over the PSTN to a first commercial access providing computer in Toronto. '350 patent, col. 9: 16-18. Alice then enters Bob's telephone number. Id." (Doc. No. 82 at 10-11). What eBay omits from the cited disclosure at col. 9, lines 16-18 ("the call originator will dial the local UniPost Access Node and enter his account and the number of the recipient") is that Alice, after using the local PSTN to call the Toronto UniPost Access Node, must "enter[s] his [her] account" and then Bob's telephone number. The account number is what gives Alice access to the UniPost Access Node and allows her to make the telephone call. And according to the specification, account numbers are provided to "subscribers."

c) Conclusion

In view of the foregoing, therefore, the Court concludes that:

The phrase "commercial access provider" in claim 1 and its dependent claims means "a service provider that provides subscription-based services and uses a computer system commercially available to telephone users that acts to provide an interface to or from the Internet." The phrase "commercial access provider" in the remaining asserted claims means "a service provider that provides subscription-based services and uses a computer system commercially available to telephone users that acts to provide an interface to or from a digitized packet based network."

IDT has used the phrase "subscription-based services" in its proposed construction and throughout the briefing. eBay has never asserted that phrase requires separate explanation in resolving the issues of infringement and validity (or any other issue) in this case. However, if that is-or becomes-an issue, the Court does not foreclose further consideration.

2. "node"

This term appears in claims 1, 2, 5, 6, 8, 10, 11, 12, 14 and 17. Claim 1 is representative (the disputed term is in boldface):

1. A method of forming a long distance communication channel between two telephone devices each of which are connected to a PSTN, said method comprising

a user of one of said telephone devices initiating and establishing a telephone communication with a first commercial access provider **node** of INTERNET and providing thereto a telephone address,

using INTERNET to establish a communication channel between said first commercial access provider **node** and a second commercial access provider **node** of INTERNET and providing said telephone address to said second commercial access provider **node**,

said second commercial access provider **node** using said telephone address and a telephone dial out capability of said second commercial access provider node to establish a communication with a telephone

device at the telephone address using a PSTN, and

using the INTERNET communication channel to link said telephone devices and form a real time voice communication between said telephone devices.

a) The Parties' Proposed Constructions

The parties propose the following constructions:

<i>eBay</i>	<i>IDT</i>
Connection points within the system, such as computers or other hardware and/or software.	A point of connection into a network, such as a computer.

See Doc. No. 99 at 33 (JCCC Exhibit 1 at 31)

eBay urges that "[t]he commercial access provider computer system includes 'nodes,' which are simply connection points within the system, such as computers or other hardware and/or software." (Doc. No. 82 at 17).

IDT urges that "[e]ach independent claim makes clear that the nodes are entry points into a network," (Doc. No. 86 at 6), pointing to claim 1 calling for "initiating and establishing a telephone communication with a first ... node of INTERNET." IDT also points to Fig. 5 and the accompanying specification illustrating and describing a "UniPost Access Node" as an entry point to a net work. (Doc. No. 86 at 6-7). IDT further relies, *inter alia*, on NEWTON'S TELECOM DICTIONARY, 8th ed., 1994 at 707, defining "node" as "a point of connection into a network." With respect to eBay's proposed construction, IDT acknowledges that a "node" can be a connection point "within" a network. However, IDT argues that is not how the term is used in the '350 patent. According to IDT, "[e]ach part of the specification that eBay contends supports its definition of 'node' describes a node as a 'commercial access providing computer' into a network, or a point of access into the network, not a connection point within a network." (Doc. No. 86 at 8).

eBay in its reply asserts that the '350 patent also describes "nodes" that are "within" the system. eBay points to the disclosure at col. 7, lines 24-31 and lines 47-56. eBay urges that "a user traveling to Tokyo calls a node in Tokyo to retrieve messages stored on a node in Toronto," and "[t]he Tokyo node connects to the Toronto node over the Internet, the user's messages are transmitted from the Toronto node to the Tokyo node, and the user then retrieves her messages over her telephone connection directly with the Tokyo node." (Doc. No. 91 at 7). eBay says that in that embodiment, "there is a single connection point into the system- the Tokyo node," and the "Toronto node is an internal connection point for data transmission *within* the system, although it is still a 'node.'" *Id.* eBay urges that the dictionary definitions IDT relies on should be disregarded because they contradict the teachings of the '350 patent. *Id.*

b) Discussion

As IDT and eBay both agree, the term "node" may refer to a junction point "within" a network. *See e.g.*, MCGRAW-HILL DICTIONARY OF SCIENTIFIC AND TECHNICAL TERMS (5th ed.1994) at 1349 defining "node" in the field of electronics as "[a] junction point within a network." eBay is also correct that in the embodiment described in col. 7, the Toronto "node" is "within" the system-while the Tokyo "node" provides access "into" the system. But the embodiment described in column 7 is the messaging embodiment of Fig. 3. IDT is correct that in the embodiment of Fig. 5, the "nodes" 6 provide access "into" the network.

In the context of claim 1:

a user of one of said telephone devices initiating and establishing a telephone communication with a first commercial access provider **node** of INTERNET and providing thereto a telephone address,

....

said second commercial access provider **node** using said telephone address and a telephone dial out capability of said second commercial access provider node to establish a communication with a telephone device at the telephone address using a PSTN, and

both "nodes" are clearly providing points of connection into a network-in this case the Internet. The same is true for the remainder of the asserted claims.

Although there is a presumption that same term bears the same meaning throughout a patent, that is not always true. It depends on the context in which the term is used. *See e.g., Yingbin-Nature (Guangdong) Wood Indus. Co. v. U.S. Int'l Trade Comm'n*, 535 F.3d 1322, 1338 (Fed.Cir.2008) ("the ALJ had no trouble correctly distinguishing, in context, between the patentee's use of the term 'clearance' in claim 5 to describe an internal void in coupled panels, and in claim 17 to describe the indentation of an uncoupled panel that defines an internal void upon coupling.").

c) Conclusion

In view of the foregoing, the Court concludes that:

The term "node," as used in the asserted claims of the '350 patent, means "a point of connection into a network, such as a computer."

3. "commercial access provider node," "commercial access nodes" and "provider node"

This term appears in claims 1, 5, 6, 8, 10, 12, 14 and 17. Claim 1 is representative (the disputed term is in boldface):

1. A method of forming a long distance communication channel between two telephone devices each of which are connected to a PSTN, said method comprising

a user of one of said telephone devices initiating and establishing a telephone communication with a first **commercial access provider node** of INTERNET and providing thereto a telephone address,

using INTERNET to establish a communication channel between said first **commercial access provider node** and a second **commercial access provider node** of INTERNET and providing said telephone address to said second **commercial access provider node**,

said second **commercial access provider node** using said telephone address and a telephone dial out capability of said second **commercial access provider node** to establish a communication with a telephone device at the telephone address using a PSTN, and

using the INTERNET communication channel to link said telephone devices and form a real time voice communication between said telephone devices.

a) The Parties' Proposed Constructions

The parties propose the following constructions:

<i>eBay</i>	<i>IDT</i>
Commercial access provider = a computer system commercially available to telephone users that acts to provide an interface to or from the Internet.	A node operated by a commercial access provider.
Node = connection points within the system, such as computers or other hardware and/or software.	

See Doc. No. 99 at 18 (JCCC Exhibit 1 at 16).

b) Discussion

The parties rely on their respective constructions for "commercial access provider" and "node." The disputed meanings of those terms have been resolved above. The parties do not contend that there is a difference in meanings between "commercial access provider node," "commercial access nodes" and "provider node."

However, it is not clear what IDT intends by "operated by." In the context of the claims and specification, it would seem that a "commercial access provider node" (and similar terms) simply means "a node of a commercial access provider."

c) Conclusion

In view of the foregoing, therefore, the Court concludes that:

The terms "commercial access provider node," "commercial access nodes" and "provider node" in the asserted claims of the '350 patent mean "a node of a commercial access provider."

4. "first commercial access provider node", "first provider node"

Those terms appear in claims 1, 2, 6, 8, 10, 12, 14 and 17. Claim 1 is representative (the disputed term is in boldface):

1. A method of forming a long distance communication channel between two telephone devices each of which are connected to a PSTN, said method comprising

a user of one of said telephone devices initiating and establishing a telephone communication with a **first commercial access provider node** of INTERNET and providing thereto a telephone address,

using INTERNET to establish a communication channel between said **first commercial access provider node** and a second commercial access provider node of INTERNET and providing said telephone address to said second commercial access provider node,

said second commercial access provider node using said telephone address and a telephone dial out

capability of said second commercial access provider node to establish a communication with a telephone device at the telephone address using a PSTN, and

using the INTERNET communication channel to link said telephone devices and form a real time voice communication between said telephone devices.

a) The Parties' Proposed Constructions

The parties propose the following constructions:

<i>eBay</i>	<i>IDT</i>
Commercial access provider = a computer system commercially available to telephone users that acts to provide an interface to or from the Internet.	A first node of a commercial access provider of INTERNET or digitized packet-based network, where the first node is capable of identifying a second commercial access provider node of INTERNET or digitized packet based network based on the telephone address provided by the user.
Node = connection points within the system, such as computers or other hardware and/or software.	

See Doc. No. 99 at 23 (JCCC Exhibit 1 at 21).

b) Discussion

eBay relies on its constructions for "commercial access provider" and "node." IDT argues that its proposed construction "recognizes the special function of the first provider node as identifying a second node of the same commercial access provider using the telephone address provided by the call originator (or user)." (Doc. No. 86 at 14).

eBay replies that there is no support in the '350 patent for IDT's proposed construction, and urges, *inter alia*, that "nothing in the specification requires that *the first node itself* must select the destination node." (Doc. No. 91 at 8). eBay urges that "other hardware or software components of the commercial access provider may select the destination node and then instruct the first node to send data to that destination." *Id.*

IDT in its sur-reply argues that the asserted claims "require that the first and second node[s] form a communication channel or segment," and "[b]efore the channel or segment can be formed, the second node must be identified: the first node identifies the second node." (Doc. No. 94 at 4).

Using claim 1 as representative, the step of

using INTERNET to establish a communication channel between said first commercial access provider node and a second commercial access provider node of INTERNET and providing said telephone address to said second commercial access provider node,

does not require that the "first commercial access provider node" "identify" the "second commercial access provider node." The step simply requires "using" the Internet to establish a communication channel between those two nodes. IDT attempts to read too much into "first commercial access provider node." Accordingly, IDT's proposed construction is rejected.

In this instance, it is clear from the claim language, as well as the specification, that "first" (and "second") are simply being used to distinguish between the two nodes. "[T]he use of the terms 'first' and 'second' is a common patent-law convention to distinguish between repeated instances of an element or limitation." *Free Motion Fitness, Inc. v. Cybex Int'l*, 423 F.3d 1343, 1348 (Fed.Cir.2005) (quoting *3M Innovative Props. Co. v. Avery Dennison Corp.*, 350 F.3d 1365, 1371 (Fed.Cir.2003)).

c) Conclusion

In view of the foregoing, the Court concludes that having resolved the parties' dispute, no further construction is necessary.

5. "second commercial access provider node," "second provider node" and "further commercial access provider node"

These terms appear in claims 1, 8, 10, 12, 14 and 17. Claim 1 is representative (the disputed term is in boldface):

1. A method of forming a long distance communication channel between two telephone devices each of which are connected to a PSTN, said method comprising

a user of one of said telephone devices initiating and establishing a telephone communication with a first commercial access provider node of INTERNET and providing thereto a telephone address,

using INTERNET to establish a communication channel between said first commercial access provider node and a **second commercial access provider node** of INTERNET and providing said telephone address to said second commercial access provider node,

said **second commercial access provider node** using said telephone address and a telephone dial out capability of said second commercial access provider node to establish a communication with a telephone device at the telephone address using a PSTN, and

using the INTERNET communication channel to link said telephone devices and form a real time voice communication between said telephone devices.

a) The Parties' Proposed Constructions

The parties propose the following constructions:

<i>eBay</i>	<i>IDT</i>
Commercial access provider = a computer system commercially available to telephone users that acts to provide an interface to or from the Internet.	A second node of the same commercial access provider of INTERNET or digitized packet-based network, which uses the local PSTN to connect the user to the telephone address provided by the user.
Node = connection points within the system, such as computers or other hardware and/or software.	

b) Discussion

IDT urges that its construction is supported by the claim language (*e.g.*, "a telephone dial out capability of said second commercial access provider node to establish a communication with a telephone device at the telephone address using a PSTN"), as well as the specification and prosecution history which provide that the second "must make a local call to the desired caller." (Doc. No. 86 at 15-16).

eBay urges that importing the functional language of the remainder of the claim into "second commercial access provider node" renders the subsequent language redundant. (Doc. No. 91 at 8-9). eBay also urges that IDT's proposed construction is wrong because the proposed construction (1) requires that the "second node" must be "of the same commercial access provider," and (2) limits the second node to a "local" PSTN-eBay notes that the abstract also refers to a "shorter long distance call." *Id.*

IDT, in its sur-reply, points to the Rule 132 declaration by Romao (which is discussed above) and his comment that "local PSTNs complete the communication." (Doc. No. 94 at 5). IDT thus argues that limiting "second commercial access provider node" to a "local PSTN" is appropriate.

As noted above, the Romao declaration was submitted in response to a rejection under s. 112(1) for lack of enablement. In that context, Romao wrote: "The commercial access providers function like the local area network [of the prior art] with respect to the signals provided thereto, and the local PSTNs complete the communication. This arrangement makes it possible for the multitude of existing conventional telephones to utilize the system in a very simple manner." Romao was not urging that the invention was limited to placing "local" PSTN calls. In all events, Romao's statement does not constitute such a clear and unambiguous statement as to create prosecution history disclaimer. *See Omega Eng'g, Inc. v. Raytek Corp.*, 334 F.3d 1314, 1323-26 (Fed.Cir.2003); *Voda v. Cordis Corp.*, 536 F.3d 1311, 1321 (Fed.Cir.2008)("The prosecution history can assist the court in understanding how an inventor understood and described his invention and whether the inventor disclaimed or disavowed certain subject matter from the scope of his claims. This court has emphasized, however, that in order to disavow claim scope during prosecution 'a patent applicant must clearly and unambiguously express surrender of subject matter.'").

IDT secondly argues that its proposed construction does not render the remainder of the claim language redundant, but rather "properly construes the claim language" in light of Romao's comment. (Doc. No. 94 at 5). The Court disagrees-Romao's comment does not constitute a disclaimer, and the proposed construction *does* render subsequent claim language redundant.

IDT also argues that "in the background and summary of the invention, and in every example in the specification, the commercial access provider maintains the computer system of distributed access nodes and the first and second nodes are of the *same computer system.*" (Doc. No. 94 at 5) (emphasis by IDT). IDT further urges that eBay's interpretation, *i.e.*, that there may be two different commercial access providers, "would exclude the preferred embodiment (the UniPost commercial access provider) and the inventor's implementation (the Global Carrier Services system)." *Id.* at 6.

Insofar as the preferred embodiment (Fig.5) is concerned, the Court disagrees. Certainly Fig. 5 and the accompanying description refer to a "UniPost" system and UniPost Access Nodes. However, nothing in the claims, specification or prosecution history require that each of the nodes be maintained or offered by the same "commercial access service provider."

Accordingly, the Court rejects IDT's proposed construction.

c) Conclusion

In view of the foregoing, including the construction of "first commercial access provider node" and the rejection of IDT's proposed construction, the Court concludes that no further construction is necessary.

6. "digitized packet based network"

This phrase appears in claims 8, 10, 12, 14 and 18. Claim 8 is representative (the disputed term is in boldface):

8. A method of establishing a long distance telephone communication between an initiating telephone device and a receiving device telephone identified by a telephone address, said method comprising using a PSTN to initiate a telephone communication with a commercial access provider node of a **digitized packet based network** and provide the node with said telephone address, said commercial access provider node causing a real time voice communication channel to be formed between said telephone devices, which communication channel includes an initial PSTN segment between the initiating telephone device and said commercial access provider node a **digitized packet based network** segment between said commercial access provider node, and a further commercial access provider node and a PSTN segment between said further commercial access provider node and the telephone device identified by the telephone address, wherein the further commercial access provider node uses the telephone address and the PSTN to initiate the PSTN segment therebetween. [paragraphing added by the parties]

a) The Parties' Proposed Constructions

The parties propose the following constructions:

<i>eBay</i>	<i>IDT</i>
No construction is needed. The claim term's ordinary meaning governs.	A packet based network that is not a local area network ("LAN") or a wide area network ("WAN").

See Doc No. 99 at 38 (JCCC Exhibit 1 at 36).

IDT revised its construction in the JCCC allegedly to narrow the dispute between the parties. eBay disagrees that IDT's revised construction narrowed the dispute.

In the briefing, IDT urged that "digitized packet based network" meant "[a] common-available global communication packet network." (Doc. No. 86 at 11). IDT urged, for example, that the "Summary of the Invention" referred to "a global voice mail and fax mail system." IDT also referred to portions of the prosecution history in which the applicant, according to IDT, disclaimed LAN and WAN systems.

eBay urges that the fact that the invention of the '350 *can* be used for international calls, does not mean that

the invention is *limited* to international calls. (Doc. No. 91 at 10). eBay also argues that it did not disclaim LANs and WANs during prosecution. *Id.*

b) Discussion

Given IDT's revised construction, the dispute seems to be whether the applicant disclaimed LANs and WANs during prosecution. IDT relies on two responses. The first was the applicant's response of July 28, 1998, and the applicant's arguments distinguishing a prior art reference to Ramjee. The second, appearing in the same response, was the applicant's argument distinguishing a prior art reference to Henley. At the time of the response, the claims used the term "INTERNET." The subsequent response of February 2, 1999, changed "INTERNET" or "INTERNET services" in some of the claims to "digitized packet based network." (Doc. No. 86-8 at 52).

In connection with Ramjee, the applicant, in arguing over an obviousness rejection applied to application claims 24, 26, 35 and 38, *i.e.*, dependent claims calling for encrypted signals, urged that "[t]here is no incentive to combine Ramjee with the Adams, Jr. *et al.* reference as in the Ramjee system, communication is over a wide area network, and as such, there is full control over the network. It is not across a public network involving an INTERNET like segment as required by the present claims." *Id.* at 29.

In connection with Henley, which the PTO asserted anticipated certain claims, the applicant argued that (1) "Henley *et al.* does not disclose a system which would allow a long distance communication channel to be formed between two telephone devices, each of which are connected to a PSTN," (2) "Furthermore, there is no INTERNET communication channel between a first and second commercial access provider and providing to the second commercial access provider the telephone address, nor is there any out dial capability of the second commercial access provider ...," (3) "Henley's arrangement is for use with a local area network or wide area network and again, has no ability for conventional devices to use a PSTN to arrange communication over INTERNET through commercial access provide nodes as specified in the present application." *Id.*

As noted above, in order to invoke prosecution history disclaimer, "a patent applicant must clearly and unambiguously express surrender of subject matter." *Voda v. Cordis Corp.*, 536 F.3d at 1321; *Omega Eng'g, Inc. v. Raytek Corp.*, 334 F.3d at 1323-26. In the passages that IDT relies on, the applicant did not "clearly and unambiguously" disclaim coverage for LANs and WANs.

Accordingly, the Court rejects IDT's proposed construction.

c) Conclusion

In view of the foregoing, and the Court's rejection of IDT's proposed construction, it appears that the parties' dispute has been resolved. Thus, no further construction is deemed necessary.

7. "means to allow users to initiate a telephone communication with a desired telephone device identified by a telephone address"

This phrase appears in claim 12 (the disputed term is in boldface):

12. A communication arrangement for long distance telephone to telephone voice communication comprising a first provider node of a digitized packet based network having **means to allow users to**

initiate a telephone communication with a desired telephone device identified by a telephone address by the steps of initially forming a communication with said first provider node and providing said telephone address thereto,

said first provider node cooperating with a second provider node of said digitized packet network to form a real time voice communication channel therebetween and said second provider node including dial out capabilities which are used upon receipt of the telephone address provided thereto to form a telephone communication with the telephone device,

said second provider cooperating with said first provider node to link the telephone devices using a digitized packet based network segment between said provider nodes and using PSTN segments between the initiating telephone device and the first provider node and between the second commercial access provider node and said telephone device identified by said telephone address,

wherein the first and second provider nodes appropriately process the signals for transmission using the digitized packet based network.

a) The Parties' Proposed Constructions

The parties propose the following constructions:

<i>eBay</i>	<i>IDT</i>
Mean-Plus-Function term governed by 35 U.S.C. s. 112, para. 6. Function: allowing users to initiate a telephone communication with a desired telephone device identified by a telephone number.	Means-Plus-Function term governed by 35 U.S.C. s. 112, para. 6. Function: allowing users to initiate a telephone communication with a desired telephone device identified by a telephone number.
Structure: a bank of direct-in-dial (DID) telephone lines associated with a public switched telephone network and a commercial access providing computer system for the Internet or other data communication networks.	Structure: Indefinite, 35 U.S.C. s. 112, para. 2.

See Doc No. 99 at 42 (JCCC Exhibit 1 at 40).

b) Discussion

Section 112(6) provides:

An element in a claim for a combination may be expressed as a means or step for performing a specified function without the recital of structure, material or acts in support thereof, and such claim shall be construed to cover the corresponding structure, material, or acts described in the specification and equivalents thereof.

Section 112(6) allows "an applicant [to] describe an element of his invention by the result accomplished or the function served, rather than describing the item or element to be used...." Warner-Jenkinson Co. v. Hilton Davis Chem. Co., 520 U.S. 17, 27 (1997).

Even though the parties may agree that a limitation is drafted in means-plus-function form, the Court must nevertheless decide as a matter of law whether a particular term or phrase is governed by s. 112(6). *See Phillips*, 415 F.3d at 1212; *Lighting World, Inc. v. Birchwood Lighting, Inc.*, 382 F.3d 1354, 1358 (Fed.Cir.2004) ("The task of determining whether the limitation in question should be regarded as a means-plus-function limitation, like all claim construction issues, is a question of law for the court, even though it is a question on which evidence from experts may be relevant."); *Personalized Media Communications, LLC v. Int'l Trade Comm'n*, 161 F.3d 696, 702 (Fed.Cir.1998).

"Once a court concludes that a claim limitation is a means-plus-function limitation, two steps of claim construction remain: 1) the court must first identify the function of the limitation; and 2) the court must then look to the specification and identify the corresponding structure for that function." *Biomedino, LLC v. Waters Techs. Corp.*, 490 F.3d 946, 950 (Fed.Cir.2007). *See Elbex Video, Ltd. v. Sensormatic Elecs. Corp.*, 508 F.3d 1366, 1370 (Fed.Cir.2007) ("Once the function has been identified, we turn to the specification to determine which structures disclosed in the specification perform that function."); *Medtronic, Inc. v. Advanced Cardiovascular Systems, Inc.*, 248 F.3d 1303, 1311 (Fed.Cir.2001) ("Structure disclosed in the specification is 'corresponding' structure only if the specification or prosecution history clearly links or associates that structure to the function recited in the claim." (quoting *B. Braun Med., Inc. v. Abbott Labs.*, 124 F.3d 1419, 1424 (Fed.Cir.1997))).

The parties agree that the limitation is drafted as a means-plus-function limitation governed by s. 112(6), and the Court concurs. The parties further agree that the recited function is "allowing users to initiate a telephone communication with a desired telephone device identified by a telephone number." Again, the Court concurs. Accordingly, the focus turns to identifying the "corresponding structure" identified in the specification for performing the recited function.

eBay contends that the "corresponding structure" is "a bank of direct-in-dial (DID) telephone lines associated with a public switched telephone network and a commercial access providing computer system for the Internet or other data communication networks." (Doc. No. 82 at 32-33). eBay contends that "structure" is expressly linked to the recited function in the specification at col. 9, lines 1-10. IDT does not disagree. The Court concurs.

IDT urges that claim 12 is invalid as indefinite under 35 U.S.C. s. 112(2) because the '350 patent does not disclose the underlying algorithms or computer software for the "computer system." (Doc. No. 86 at 23). IDT relies on *Aristocrat Tech. v. Int'l Game Tech.*, 521 F.3d 1328, 1333 (Fed.Cir.2008); *Harris Corp. v. Ericsson, Inc.*, 417 F.3d 1241, 1253 (Fed.Cir.2005); and *WMS Gaming, Inc. v. Int'l Game Tech.*, 184 F.3d 1339, 1349 (Fed.Cir.1999). eBay contends that those cases do not apply because the claim is not drawn to a computer algorithm, but rather to a telecommunications system. (Doc. No. 91 at 12). eBay also argues that the structure it has identified is not a "general purpose computer," but rather "a computer system that (1) provides an interface to the public telephone network through a bank of direct-in-dial (DID) telephone lines, and also (2) provides access to the Internet or other packet based network, through which it routes voice data received from the PSTN." *Id.*

IDT, in its sur-reply, notes that in *Harris* the invention was also directed to a telecommunication system implemented by a computer, and that one cannot avoid a conclusion of indefiniteness by recasting a computer as one for performing the function of the claim term. (Doc. No. 94 at 8).

In *In re Donaldson*, 16 F.3d 1189, 1195 (Fed.Cir.1994), the Federal Circuit explained the relationship

between s. 112(6) and s. 112(2):

Although paragraph six statutorily provides that one may use means-plus-function language in a claim, one is still subject to the requirement that a claim "particularly point out and distinctly claim" the invention. Therefore, if one employs means-plus-function language in a claim, one must set forth in the specification an adequate disclosure showing what is meant by that language. If an applicant fails to set forth an adequate disclosure, the applicant has in effect failed to particularly point out and distinctly claim the invention as required by the second paragraph of section 112.

In *Aristocrat Tech. v. Int'l Game Tech.*, 521 F.3d at 1330-31, the district court concluded that "game control means" in a means-plus-function limitation performed three functions: "(1) to control images displayed on the display means; (2) to pay a prize when a predetermined combination of symbols matches the symbol positions selected by the player; and (3) to define the pay lines for the game according to each possible combination of the selected symbol positions." *Aristocrat* argued that the structure disclosed in the specification, namely "any standard microprocessor base [sic] gaming machine [with] appropriate programming," was a sufficient disclosure of structure. 521 F.3d at 1332-33. The Federal Circuit disagreed.

The Federal Circuit explained that:

In cases involving a computer-implemented invention in which the inventor has invoked means-plus-function claiming, this court has consistently required that the structure disclosed in the specification be more than simply a general purpose computer or microprocessor. The point of the requirement that the patentee disclose particular structure in the specification and that the scope of the patent claims be limited to that structure and its equivalents is to avoid pure functional claiming.... "If the specification is not clear as to the structure that the patentee intends to correspond to the claimed function, then the patentee has not paid the price but is attempting to claim in functional terms unbounded by any reference to structure in the specification." ... For a patentee to claim a means for performing a particular function and then to disclose only a general purpose computer as the structure designed to perform that function amounts to pure functional claiming. Because general purpose computers can be programmed to perform very different tasks in very different ways, simply disclosing a computer as the structure designated to perform a particular function does not limit the scope of the claim to "the corresponding structure, material, or acts" that perform the function, as required by section 112 paragraph 6.

521 F.3d at 1333.

In *Net MoneyIn, Inc. v. Verisign, Inc.*, 545 F.3d 1359, 1367 (Fed.Cir.2008), the Federal Circuit reiterated that:

A patent applicant who employs means-plus-function language "must set forth in the specification an adequate disclosure showing what is meant by that language. If an applicant fails to set forth an adequate disclosure, the applicant has in effect failed to particularly point out and distinctly claim the invention as required by the second paragraph of section 112." ... To avoid purely functional claiming in cases involving computer-implemented inventions, we have "consistently required that the structure disclosed in the specification be more than simply a general purpose computer or microprocessor." ... "Because general purpose computers can be programmed to perform very different tasks in very different ways, simply disclosing a computer as the structure designated to perform a particular function does not limit the scope of the claim to 'the corresponding structure, material, or acts' that perform the function, as required by section

112 paragraph 6." ... "Thus, in a means-plus-function claim 'in which the disclosed structure is a computer, or microprocessor, programmed to carry out an algorithm, the disclosed structure is not the general purpose computer, but rather the special purpose computer programmed to perform the disclosed algorithm.' " ... Consequently, a means-plus-function claim element for which the only disclosed structure is a general purpose computer is invalid if the specification fails to disclose an algorithm for performing the claimed function.

In *Net MoneyIn*, there were two patents-in-suit. The parties agreed that the function of a means-plus-function limitation in the first patent-in-suit was "generating an authorization indicia in response to queries containing a customer account number and amount." 545 F.3d at 1365. In the second patent-in-suit, the district court construed the function as "the financial processing computer receives both the customer account data and amount data from both the customer computer and the merchant computer." 545 F.3d at 1367. *Net MoneyIn* argued that "the specification does disclose a 'bank computer' and this Court's precedents do not require a description of the 'internal structure' of the 'bank computer.'" The Federal Circuit disagreed and found the claims indefinite.

With respect to eBay's first argument that those cases do not apply because claim 12 is not drawn to a computer algorithm, but rather to a telecommunications system, eBay points to no case so holding. Indeed, in *Aristocrat*, the Federal Circuit noted that "[i]n cases involving a computer-implemented invention in which the inventor has invoked means-plus-function claiming, this court has consistently required that the structure disclosed in the specification be more than simply a general purpose computer or microprocessor." The Federal Circuit reiterated the same in *Net MoneyIn*. Moreover, the recited functions in those cases were not "computer algorithms," but rather functions involved in performing the claimed invention, *e.g.*, "receiv[ing] both the customer account data and amount data from both the customer computer and the merchant computer," and "control[ing] images displayed on the display means."

The point is, s. 112(6) specifies how means-plus-function limitations are construed, *i.e.*, "to cover the corresponding structure, material, or acts described in the specification and equivalents thereof." As expressed in *Donaldson* and the rest of the cases, a party certainly has no obligation to use means-plus-function limitations—such limitations are simply *permitted* by s. 112(6). When a party chooses to use means-plus-function limitations, however, there is a trade-off—namely one must disclose "the corresponding structure, material, or acts" that perform the recited function(s) because, per the terms of s. 112(6), the scope of the claim depends on that disclosed structure.

The point made in *Aristocrat*, *Net MoneyIn*, and predecessor cases, is that when the disclosed "corresponding structure" for performing a recited function includes a general purpose computer, additional disclosure is necessary to meet the claim definiteness requirements of s. 112(2). Without disclosure of an algorithm for performing the claimed function, a means-plus-function limitation implemented using a computer would cover a "computer" however programmed. And that is not the law. *See Harris*, 417 F.3d at 1253 (" *WMS Gaming* restricts computer-implemented means-plus-function terms to the algorithm disclosed in the specification."). Accordingly, failure to disclose an algorithm for performing the claimed function results in (1) a failure to disclose sufficient structure for performing the claimed function per s. 112(6), and (2) claim indefiniteness under s. 112(2).

In that regard, as the Federal Circuit explained in *Aristocrat*, 521 F.3d at 1336, that it is not enough to argue that one of ordinary skill in the art would be able to program a computer to perform the recited function: "Aristocrat also argues that, even if there is no disclosure of an algorithm in the patent, the disclosure of a

microprocessor with 'appropriate programming' is a sufficient disclosure of structure for means-plus-function purposes, because the evidence showed that one of ordinary skill in the art could build the device claimed in the [patent-in-suit] based on the disclosure in the specification. That argument, however, conflates the requirement of enablement under section 112 paragraph 1 and the requirement to disclose the structure that performs the claimed function under section 112 paragraph 6.... Enablement of a device requires only the disclosure of sufficient information so that a person of ordinary skill in the art could make and use the device. A section 112 paragraph 6 disclosure, however, serves the very different purpose of limiting the scope of the claim to the particular structure disclosed, together with equivalents."

Similarly, contending, as eBay does here, that the structure it has identified is not a "general purpose computer," but rather "a computer system that (1) provides an interface to the public telephone network through a bank of direct-in-dial (DID) telephone lines, and also (2) provides access to the Internet or other packet based network, through which it routes voice data received from the PSTN," *i.e.*, specifying the functions that the "computer system" must perform, is unavailing. eBay points to no disclosure in the specification of the '350 patent of an algorithm for performing the same.

Here, the parties are agreed that the recited function is "allowing users to initiate a telephone communication with a desired telephone device identified by a telephone number." eBay asserts, and IDT does not disagree, that the "corresponding structure" disclosed in the specification is "a bank of direct-in-dial (DID) telephone lines associated with a public switched telephone network and a commercial access providing computer system for the Internet or other data communication networks." There is thus no question a "computer system" is required to perform the recited function. eBay, once again, points to no disclosed algorithm for performing that function.

IDT urges, as a result, that claim 12 is invalid under s. 112(2). eBay, on the other hand, notes that under s. 282 patents are presumed valid, and therefore a challenger incurs the burden of proving invalidity by clear and convincing evidence. Although claim definiteness and claim construction are necessarily intertwined, the Federal Circuit also noted in *Atmel Corp. v. Info. Storage Devices, Inc.*, 198 F.3d 1374, 1378 (Fed.Cir.1999), that "[w]e agree with *Atmel* that the district court erred in its analysis under s. 112, para. 2 and should have determined whether sufficient structure was disclosed in the specification based on the understanding of one skilled in the art," subject, however, to *Atmel's* progeny. *See e.g.*, *Aristocrat*, 521 F.3d at 1337 ("That principle [of *Atmel*], however, has no application here, because in this case there was no algorithm at all disclosed in the specification. The question thus is not whether the algorithm that was disclosed was described with sufficient specificity, but whether an algorithm was disclosed at all.").

The Court at this juncture declines to conclude that claim 12 is invalid as indefinite under s. 112(2). That issue is reserved to the time of dispositive motions.

c) Conclusion

In view of the foregoing, the Court concludes that, in claim 12, "means to allow users to initiate a telephone communication with a desired telephone device identified by a telephone address" is a means-plus-function limitation governed by s. 112(6). The parties are agreed that the recited function is "allowing users to initiate a telephone communication with a desired telephone device identified by a telephone number." The parties are agreed that the "corresponding structure" disclosed in the specification for performing that recited function is "a bank of direct-in-dial (DID) telephone lines associated with a public switched telephone network and a commercial access providing computer system for the Internet or other data communication

networks."

The Court finds no computer algorithm for performing the recited function disclosed in the specification. Whether claim 12 is invalid as a result is reserved to dispositive motions.

Also, eBay has not expressly argued that the "corresponding structure" disclosed in the specification is a "special purpose" computer, as opposed to a general purpose computer programmed to perform certain tasks. If that is-or becomes-an issue, the Court does not foreclose further argument on that issue.

8. "appropriate digitized packet based communication channel," "appropriately process the signals for transmission"

Those phrases appear in claims 10 and 12 (the disputed phrases are in boldface):

10. A method of forming a long distance telephone communication between a first telephone device and a second telephone device which communication is capable of transmitting real time voice communications similar to existing long distance voice telephone communications, comprising the steps of

forming an initial telephone link between the first telephone device and a commercial access provider node of a digitized packet based network and providing thereto a telephone address of the second telephone device, said commercial access provider forming an **appropriate digitized packet based communication channel** with a further commercial access provider node located in closer proximity to the location of the second telephone device and providing thereto said telephone address, said further commercial access provider establishing a telephone link with said second telephone device using said telephone address, and then linking said telephone devices using said digitized packet based communication channel thereby forming a real time voice communication between said telephone devices.

12. A communication arrangement for long distance telephone to telephone voice communication comprising a first provider node of a digitized packet based network having means to allow users to initiate a telephone communication with a desired telephone device identified by a telephone address by the steps of initially forming a communication with said first provider node and providing said telephone address thereto,

said first provider node cooperating with a second provider node of said digitized packet network to form a real time voice communication channel therebetween and said second provider node including dial out capabilities which are used upon receipt of the telephone address provided thereto to form a telephone communication with the telephone device,

said second provider cooperating with said first provider node to link the telephone devices using a digitized packet based network segment between said provider nodes and using PSTN segments between the initiating telephone device and the first provider node and between the second commercial access provider node and said telephone device identified by said telephone address,

wherein the first and second provider nodes **appropriately process the signals for transmission** using the digitized packet based network.

a) The Parties' Proposed Constructions

The parties propose the following constructions:

<i>eBay</i>	<i>IDT</i>
No construction is needed. The claim term's ordinary meaning governs.	Indefinite, 35 U.S.C. s. 112, para. 2.

See Doc. No. 99 at 43 (JCCC Exhibit 1 at 41).

b) Discussion

IDT urges that "[t]he intrinsic and extrinsic record provide no indication as to when a digitized packet based communication channel becomes 'appropriate.' " Moreover, IDT says, "a person of ordinary skill in the art would not know what the term 'appropriate' relates to—the geographical reach of the 'digitized packet based communication channel,' its bandwidth capability to carry communications, the ability to control the quality of transmitted voice communications, the ability to route the calls in the most efficient/least-cost way, or something entirely different." (Doc. No. 86 at 25). IDT urges that the "circumstances here are analogous to the one in *Halliburton Energy Servs., Inc. v. M-1 LLC*, 514 F.3d 1244 (Fed.Cir.2008)." *Id.* IDT argues that "a person of ordinary skill in the art would not know when a signal is 'appropriately' processed for transmission, and therefore the term 'appropriately process the signals for transmission' is indefinite." (Doc. No. 86 at 26).

eBay responds that "[i]n the context of the claim, the term 'appropriate' simply means that the communication channel is suitably formed to achieve the intended purpose of the invention, a long distance voice communication between the users. It is independent of the factors identified by Defendants, such as geographical reach, bandwidth, *etc.*" (Doc. No. 91 at 13). eBay also asserts that the district court in *Billingnetwork Patent, Inc. v. Cerner Physician Practice, Inc.*, 2006 U.S. Dist. LEXIS 5995 at *46-49 (M.D.Fla.2006), held that "appropriate" was not indefinite because "a person skilled in the art reading the specification would understand that the term 'is not subject to a purely subjective definition.' " eBay says that the "same is true here." (Doc. No. 91 at 13).

IDT responds that in *Billingnetwork* the court found that the specification gave an explanation for "appropriate software," which IDT contends is not present here. (Doc. No. 94 at 9-10).

In *Halliburton*, the phrase at issue was "*fragile gel* drilling fluid." In *Bancorp Servs., L.L.C. v. Hartford Life Ins. Co.*, 359 F.3d 1367, 1372 (Fed.Cir.2004), the Federal Circuit explained that:

We have held that a claim is not indefinite merely because it poses a difficult issue of claim construction; if the claim is subject to construction, i.e., it is not in-solubly ambiguous, it is not invalid for indefiniteness.... That is, if the meaning of the claim is discernible, "even though the task may be formidable and the conclusion may be one over which reasonable persons will disagree, we have held the claim sufficiently clear to avoid invalidity on indefiniteness grounds." ... By finding claims indefinite only if reasonable efforts at claim construction prove futile, we accord respect to the statutory presumption of patent validity, ... and "we protect the inventive contribution of patentees, even when the drafting of their patents has been less than ideal." ... Thus, "close questions of indefiniteness in litigation involving issued patents are properly resolved in favor of the patentee." ...

That same standard has been consistently applied, as the Federal Circuit in *Halliburton* noted: "The common thread in all of these cases is that claims were held indefinite only where a person of ordinary skill in the art

could not determine the bounds of the claims, i.e., the claims were insolubly ambiguous." 359 F.3d at 1249.

In *Datamize, LLC v. Plumtree Software, Inc.*, 417 F.3d 1342, 1345 (Fed.Cir.2005), the limitation at issue called for:

each element type having a plurality of attributes associated therewith, wherein each said element type and its associated attributes are subject to pre-defined constraints providing element characteristics in conformance with said uniform and *aesthetically pleasing* look and feel for said interface screens,

The Federal Circuit concluded, *inter alia*, that "[h]ere Datamize has offered no objective definition identifying a standard for determining when an interface screen is 'aesthetically pleasing.' In the absence of a workable objective standard, 'aesthetically pleasing' does not just include a subjective element, it is completely dependent on a person's subjective opinion." 417 F.3d at 1350.

In *Halliburton*, the Federal Circuit explained that "[t]his court has applied the definiteness requirement of 35 U.S.C. s. 112, para. 2 in numerous circumstances. For example, we have held claims indefinite where a claim ... contains a term that is 'completely dependent on a person's subjective opinion,' " citing *Datamize*, 417 F.3d at 1350. The court concluded that although *Halliburton* had provided a proposed construction for the term, "[t]he fact that *Halliburton* can articulate a definition supported by the specification, however, does not end the inquiry. Even if a claim term's definition can be reduced to words, the claim is still indefinite if a person of ordinary skill in the art cannot translate the definition into meaningfully precise claim scope. Having reviewed the remaining two parts of *Halliburton*'s proposed construction, both individually and in combination, in the context of the intrinsic record and the knowledge of a person of ordinary skill in the art, we hold that the ambiguity as to the scope of 'fragile gel' cannot be resolved." 359 F.3d at 1251.

In *Billingnetwork*, 2006 U.S. Dist. LEXIS 5995 (M.D.Fla.2006), the phrase at issue was "said database server then, utilizing an *appropriate application software* thereon, producing billing invoices and statements to clients and customers, for each corresponding browser-based subscriber." *Id.* at *45. According to the court, "Defendants argue that the term has a purely subjective meaning and does not adequately advise the public of the scope of the invention. Further, Defendants argue that the specification and prosecution history fail to provide any objective definition for determining whether software is 'appropriate.'" *Id.* at *45. Nevertheless, the court concluded, *inter alia*, that "[t]he plain language of the claim itself indicates that the 'appropriate application software' is utilized by the database server to produce billing invoices and statements to clients and customers," and that "[a]ccordingly, the phrase 'appropriate application software' is not subject to a purely subjective definition, as was the case in *Datamize*, and the Court will resolve this matter in favor of the patentee." *Id.* at *48. The situation is similar here.

IDT complains that the word "appropriate" renders the claims subjective-as opposed to objective-and therefore indefinite under s. 112(2). Certainly "appropriate" on its face has subjective connotations-but there are objective connotations as well, depending on context.

In claim 10, for example, the preamble (which the parties agree is limiting) calls for "forming a long distance telephone communication between a first telephone device and a second telephone device which communication is capable of transmitting real time voice communications similar to existing long distance voice telephone communications." The body of the claim calls for "forming an initial telephone link between the first telephone device and a commercial access provider node of a digitized packet based network," "said commercial access provider forming an *appropriate digitized packet based communication*

channel with a further commercial access provider node located in closer proximity to the location of the second telephone device," and "linking said telephone devices using said digitized packet based communication channel thereby forming a real time voice communication between said telephone devices." In context, "appropriate digitized packet based communication channel" clearly refers to a channel that allows "linking said telephone devices using said digitized packet based communication channel" to form "a real time voice communication between said telephone devices." Claim 10 is neither "insolubly ambiguous" nor "subjective."

With respect to claim 12, the claim preamble calls for "[a] communication arrangement for long distance telephone to telephone voice communication," "said first provider node cooperating with a second provider node of said digitized packet network to form a real time voice communication channel therebetween," and "wherein the first and second provider nodes appropriately process the signals for transmission using the digitized packet based network." Again, claim 12 is neither "insolubly ambiguous" nor "subjective." Whether the "first and second provider nodes appropriately process the signals for transmission using the digitized packet based network" is governed by the remainder of the claim language.

Accordingly, noting that IDT has not proposed any claim construction, and thus there is no dispute between the parties on claim construction *per se*, the Court agrees with eBay that no further claim construction is required.

Although the Court has declined to accept IDT's argument that claims 10 and 12 are invalid in the context of claim construction, that does not foreclose IDT from raising those arguments in a dispositive motion.

c) Conclusion

With respect to the phrases "appropriate digitized packet based communication channel," "appropriately process the signals for transmission" in claims 10 and 12, the Court, in the context of claim construction, does not accept IDT's argument that claims 10 and 12 are invalid under s. 112(2). However, that does not foreclose IDT from raising those arguments in a dispositive motion.

IV.

U.S. Patent Nos. 5,974,414 and 6,631,399

The '414 patent entitled, "System and Method for Automated Received Message Handling and Distribution," issued on October 26, 1999, to Mark Stanczak, Martin T. Wegner, and Omprasad S. Nandyal, from Application No. 08/886,988, filed July, 3, 1997. On its face, the '414 patent was assigned to Open Port Technology, Inc.

The '399 patent entitled, "System and Method for Automated Received Message Handling and Distribution," issued on October 7, 2003 to Mark Stanczak, Martin T. Wegner and Omprasad S. Nandyal, from Application 09/366,712, filed on August 4, 1999. On its face, the '399 patent was assigned to Open Port Technology, Inc.

The '399 patent issued from an application filed as a continuation of the application maturing into the '414 patent. Both claim priority to Provisional Application No. 60/021,125, filed on July 3, 1996. Although both the '414 and '399 share the same specification and drawings, the parties cite variously to both, although IDT mostly cites to the '414 patent, and eBay mostly cites to the '399 patent. The Court will follow each parties'

respective cites.

Net2Phone asserts that it is the current owner of the '414 and '399 patents, and that eBay infringes those patents by offering a service known as Live Help, which Net2Phone characterizes as "a chat program where users identify problems they are having with their accounts and Live Help directs those inquiries to customer service agents with the appropriate expertise." (Doc. No. 83 at 7).

A. Overview

The '414 and '399 patents relate to message distribution in public and private networks. More particularly, the patents are drawn to a system and method for routing messages received over public and private networks to an appropriate message receiving subsystem or person. According to the abstract:

An automated message distribution system routes digitally-encoded messages via public-switched telephone networks and wide area networks and local area networks to the most desired route. In a preferred embodiment of the invention, digitally encoded messages enter into a local area network, either directly or via a public-switched telephone network, and are sent to their destinations in a distributed manner. The paths or routes are calculating by using a set of customized rules. The customized rules re set to distribute messages evenly among the available paths.

'414 patent, abstract.

Further discussion of the background and disclosure of the '414 and '399 patents appears below in resolving the parties' disputed constructions.

B. Agreed Terms

The parties agree that the following terms in the '414 and '399 patents have the following meanings:

<i>Claim Term</i>	<i>Agreed Construction</i>
"daemon"	A continuously running background process.
"resource information table"	A table that maintains information regarding the resources.
"resource"	Receivers of digitally-encoded messages that are capable of processing them.
"resource load"	A group of resources.

See Doc. No. 99 at 46-57 (JCCC Exhibit 1 at 44-55).

The parties agree that the following terms in the '414 patent have the following meanings:

<i>Claim Term</i>	<i>Agreed Construction</i>
"threshold value"	A defined number of digitally-encoded messages in the distributed message queue.
"determining whether each of said digitally-encoded messages is a high- or low-priority"	Plain meaning.

See Doc. No. 99 at 58, 60 (JCCC Exhibit 1 at 56, 58).

The parties agree that the following terms in the '399 patent have the following meanings:

<i>Claim Term</i>	<i>Agreed Construction</i>
"resource information and access process"	A process that stores information pertaining to the status of the resources.
"message distributor"	Plain meaning.

See Doc No. 99 at 57, 60 (JCCC Exhibit 1 at 55, 58).

C. Asserted Claims of the '414 Patent

Net2Phone asserts claims 13 and 21 (claim 21 is dependent on claim 18, which in turn is dependent on claim 17, which in turn is dependent on claim 15—for sake of brevity, those claims are not reproduced here):

13. A method for automatically distributing digitally-encoded messages that are input to an automatic message distribution system that includes a resource load containing a plurality of resources, comprising the steps of:

- (a) storing said digitally-encoded messages in one or more distributed message queues;
- (b) storing resource information concerning said resources in a resource information table that enables the automatic message distribution system to determine which of said resources is available to process a digitally-encoded message stored in said one or more distributed message queues;
- (c) storing a set of routing rules in a distribution routing table that control distribution of said digitally-encoded messages to the resources; and
- (d) automatically routing a digitally-encoded message stored in said one or more distributed message queues
- (e) creating a primary user list of at least one primary user for each of said one or more distributed message queues;
- (f) storing said primary list in said system configuration file
- (g) creating a secondary user list of at least one secondary user for each of said one or more distribute message queues; and
- (h) storing said secondary user list in said system configuration file;
- (i) storing a count corresponding to the number of digitally-encoded messages stored in the one or more distributed message queues;
- (j) setting a first threshold value that, if reached, indicates that digitally-encoded messages are backing up in said distribution message queue when said count reaches or exceeds said first threshold value;
- (k) setting a second threshold value that, if reached, causes said daemon to use both said primary user list and said secondary user list to determine where to route said digitally-encoded messages; and

(1) setting a third threshold value that, if reached, indicates an overflow condition caused by a volume of digitally-encoded messages that is too great for said primary users and said secondary users to process; and

(m) storing each of said first, second and third threshold values in said system configuration file.

21. The method of claim 18, wherein determining step (i) comprises the step of calculating the difference between the time that each digitally-encoded message entered the automatic message distribution system and the time at which the age determination in step (i) is made.

D. Asserted Claims of the '399 Patent

Net2Phone asserts claims 2 (dependent on claim 1), 15 and 19, all of which are reproduced for reference:

1. An automatic message distribution system, comprising:

a computer;

a message distributor executing on said computer to control distribution of digitally-encoded messages that are input to the automatic message distribution system;

a resource load operatively connected to said message distributor containing resources that process said digitally-encoded messages;

a resource information maintenance and access process operatively connected to said message distributor for storing resource information pertaining to the status of said resources;

a distribution message queue operatively connected to said message distributor to store each of said digitally-encoded messages for distribution; and

a distribution rule maintenance and application process connected to said message distributor to store distribution rules for distributing said digitally-encoded messages to said resources from said distribution message queue in accordance with said resource information. [paragraphing added by the parties]

2. The automatic message distribution system of claim 1, wherein said message distributor further comprises: an automatic message distribution daemon to control distribution of said digitally-encoded messages to said resources.

15. A method for automatically distributing digitally-encoded messages that are input to an automatic message distribution system that includes a resource load containing a plurality of resources, comprising the steps of:

(a) storing each of said digitally-encoded messages in one or more distributed message queues;

(b) storing resource information concerning said resources in a resource information table that enables the automatic message distribution system to determine which of said resources is available to a digitally-encoded message stored in said one or more distributed message queues;

(c) storing a set of routing rules in a distribution routing table that control distribution of said digitally-encoded message to the resources; and

(d) automatically routing a digitally-encoded message stored in said one or more distributed message queues. [paragraphing added by the parties]

19. A The method claim 15, further comprising the steps of: (e) analyzing each of said digitally-encoded messages to determine into which of said one or more distributed message queues said digitally-encoded messages should be stored; and (f) storing each of said digitally-encoded messages in a distributed message queue that is determined in accordance with step (e).

E. Disputed Terms and Phrases

The disputed terms and phrases, with the exception of two terms, appear in the asserted claims of both the '414 and '399 patents. Net2Phone asserts that claim 15 of the '399 patent is representative of the use of the common terms.

1. "digitally-encoded messages"

The phrase appears in claims 13 and 21 (and parent claims) of the '414 patent, and claims 1, 2, 15 and 19 of the '399 patent. Claim 15 of the ' 399 patent is representative (the disputed term is in boldface):

15. A method for automatically distributing **digitally-encoded messages** that are input to an automatic message distribution system that includes a resource load containing a plurality of resources, comprising the steps of:

(a) storing each of said **digitally-encoded messages** in one or more distributed message queues;

(b) storing resource information concerning said resources in a resource information table that enables the automatic message distribution system to determine which of said resources is available to a **digitally-encoded message** stored in said one or more distributed message queues;

(c) storing a set of routing rules in a distribution routing table that control distribution of said **digitally-encoded message** to the resources; and

(d) automatically routing a **digitally-encoded message** stored in said one or more distributed message queues. [paragraphing added by the parties]

a) The Parties' Proposed Constructions

The parties propose the following constructions:

<i>eBay</i>	<i>IDT</i>
The content of a communication from a sender that has been converted into digital form, not simply an identification of the type of information to be communicated.	Digitally-encoded information from a message sender to one or more message receivers.

Net2Phone urges that the specification of the '414 and '399 patents defines the term, and thus that is the definition that should control, citing Phillips, 415 F.3d at 1316. (Doc. No. 83 at 11). Specifically, Net2Phone contends that the specification of the patents use "message" and "digitally-encoded message" interchangeably and expressly defines "message" as:

As used herein the term "message" includes any digitally-encoded information that can be transmitted by a sender to a receiver.

'414 patent, col. 4, lines 24-27. Net2Phone urges that eBay's proposed construction improperly imports a "content of a communication" limitation. (Doc. No. 83 at 12).

eBay urges that its proposed construction "follows directly from how the 'invention' is repeatedly characterized and distinguished over prior art systems in the intrinsic record." (Doc. No. 87 at 19). eBay contends that the patents "expressly distinguish prior art systems from the 'present invention' on the ground that prior art systems were only able to base routing decisions on the 'type of information that will be discussed,' whereas the 'AMD system of the present invention' receives and stores 'digitally-encoded messages,' and thus can base routing decisions on 'message content information.'" *Id.* (citing '399 patent, col. 1, lines 54-65, col. 2, lines 55-56, col. 3, lines 9-12; Open Port's Provisions Appl. at 1, 2, 4.) eBay also points to the Summary of the Invention explaining "[t]he AMD of the present invention processes information that is received in *message format* rather than as a telephone call, and therefore can base routing decisions on *message content*." (Doc. No. 87 at 19) (emphasis by eBay), (citing '399 patent, col. 2, lines 51-56, and col. 3, lines 9-12) ("Because the messages are stored, the present invention can extract *content information* from the messages for routing purposes that is not available to conventional AMD or ACD systems.") (emphasis by eBay).

eBay argues that "[i]n characterizing the 'present invention' as a content-based message routing system and distinguishing the prior art on this basis, Open Port excluded from the scope of a 'digitally-encoded message' the mere identification of the 'type of information' to be communicated." (Doc. No. 87 at 20) (citing *Curtiss-Wright Flow Corp. v. Velan, Inc.*, 438 F.3d 1374, 1378-80 (Fed.Cir.2006), and *Honeywell Int'l, Inc. v. ITT Indus.*, 452 F.3d 1312, 1318-19 (Fed.Cir.2006)).

eBay also argues that its proposed construction "makes clear that a 'digitally-encoded message' refers to the content of a communication *that has been converted into digital form*. This follows from both the description of the invention in the intrinsic record as well as the plain meaning of the term 'digitally-encoded' itself," pointing to the IEEE Standard Dictionary of Electrical and Electronics Terms (6th ed.1996) at 168, defining "encoded data" as "[d]ata that ha[s] been converted from one form of representation to another, using a set of rules." (Doc. No. 87 at 21) (emphasis added). eBay urges that " '[d]igitally-encoded' data, then, is data that has been converted into digital form so that it can be read and manipulated by a computer." *Id.* (citing '399 patent, col. 2, lines 37-48).

In response to Net2Phone's proposed construction, eBay says that the specification does not define "digitally-encoded message," but even if so, "it cannot trump how the Summary of the Invention repeated characterizes the invention and distinguishes the invention over the prior art." (Doc. No. 87 at 21-22). eBay also urges that the sentence Net2Phone relies is taken out of the overall context of the specification, which "runs afoul of the fundamental principal that the claims of a patent may not be construed broader than how the patentee characterized the 'present invention' in the intrinsic record." (Doc. No. 87 at 22).

Net2Phone responds that eBay's proposed construction "suggests that messages are digitally-encoded after receipt into a distribution system." Net2Phone urges that according to the '414 and '399 patents, messages are "digitally-encoded" when they are transmitted from a message sender to a receiver. (Doc. No. 92 at 5).

Net2Phone also says that "information" in its proposed construction refers to the many types of information that are part of a message, for example, "the identity of the sender, the type of information to be communicated, mail headers, addresses, priority of the messages, amount of time the message have been in the system, and any other information sent by the message sender, such as the actual substantive content of the communication." (Doc. No. 92 at 6). Limiting the "digitally-encoded message" to "content of a communication," Net2Phone argues, ignores the other information that the patents disclose is in the message.

With respect to distinguishing the prior art, Net2Phone argues that "when the Patents distinguished the prior art ACD systems, they were not limiting the scope of a digitally-encoded message to the actual substantive content of the communication, as eBay asserts. Rather, the Patents made clear that, unlike the prior art ACD systems, the invention *can also use* the actual substantive content of the communication to distribute a message, which was unavailable in the old ACD system." Id.

In its sur-reply, eBay reiterates that the patents "repeatedly distinguish the prior art Automatic Call Distribution ('ACD') systems on the ground that they were only able to base routing decisions on the 'type of information' to be communicated, whereas the 'AMD system of the present invention' receives and stores 'digitally-encoded messages,' and thus can base routing decisions on the actual 'message content' itself." (Doc. No. 95 at 4-5) (citing '399 patent, col. 1, lines 54-65, col. 2, lines 55-56, col. 3, lines 9-12; provisional app. at 1, 2, 4).

eBay further characterizes Net2Phone's argument that "the Patents made clear that, unlike the prior art ACD systems, *the invention can also use the actual substantive content of the communication to distribute a message*, which was unavailable in the old ACD system," (emphasis by eBay) as a "critical admission" and "exactly right." eBay urges that "[w]hat Net2Phone overlooks, however, is that the message distribution system can do so only because a 'digitally-encoded message' contains the 'actual substantive content of the communication.'" (Doc. No. 95 at 5).

eBay further disputes that its proposed construction limits a digitally-encoded message to the "content of a communication." eBay argues that under its proposed construction a "digitally-encoded message" must contain the "actual substantive content of a communication," but it may also contain other information such as e-mail headers etc. Id. at 6.

eBay also disputes Net2Phone's contention that messages are "digitally-encoded" before receipt by the distribution system. eBay contends that facsimile messages are transmitted in analog form, and then digitally encoded after they are received into the distribution system, citing the '399 patent, col. 2, lines 37-48: "The message can assume one of a number of manipulatable forms. For example, in the case of facsimile (fax) data, messages can be stored in one of the TIFF, PCX or DCX formats." Id. at 6-7.

b) Discussion

Beginning as always with the terms of the claim, and using claim 15 of the ' 399 patent as representative:

15. A method for automatically distributing *digitally-encoded messages* that are input to an automatic message distribution system that includes a resource load containing a plurality of resources, comprising the steps of:

(a) storing each of said *digitally-encoded messages* in one or more distributed message queues;

(b) storing resource information concerning said resources in a resource information table that enables the automatic message distribution system to determine which of said resources is available to a *digitally-encoded message* stored in said one or more distributed message queues;

(c) storing a set of routing rules in a distribution routing table that control distribution of said *digitally-encoded message* to the resources; and

(d) automatically routing a *digitally-encoded message* stored in said one or more distributed message queues. [paragraphing added by the parties]

eBay points to nothing in the claim language, other than the term itself, that requires that "digitally-encoded messages" include the "content of a communication from a sender." eBay further does not rely on any arguments made during prosecution. eBay relies exclusively on statements made in the "Background" and "Summary of the Invention" portions of the specifications of the patents-in-suit. And *Curtiss-Wright* and *Honeywell*.

In *Curtiss-Wright*, the patent-in-suit was drawn to a coke drum de-heading system. One of the claim limitations called for "an *adjustable* dynamic, live loaded seat coupled to said main body." The district court, in construing "adjustable," (1) began with the ordinary meaning of "adjustable": "capable of making a change to something or capable of being changed," (2) determined that a narrower construction of "adjustable" would be inconsistent with other claims, and (3) explained that any construction of the term "adjustable" that requires the presence of an adjustment mechanism disclosed in the patent-in-suit would impermissibly narrow the claim to the preferred embodiment. The district court accordingly construed "adjustable" as, *inter alia*, "not limited by any time, place, manner, or means of adjustment." The Federal Circuit reversed commenting that the district court's construction "places too much emphasis on the ordinary meaning of "adjustable" without adequate grounding of that term within the context of the specification ..." and misapplied the doctrine/guideline of claim differentiation. 438 F.3d at 1378.

The Federal Circuit explained that "the specification of the [patent-in-suit] consistently, and without exception, describes adjustment that occurs during operation of the de-header system," and that the district court's construction "which includes a structure that requires dismantling of the valve to perform the adjustment, finds no support in the overall context of the ... specification." The Federal Circuit further commented that "the district court's construction of 'adjustable' renders that limitation nearly meaningless. This court finds it difficult, if not impossible, to imagine any mechanical device that is not 'adjustable,' under the ordinary meaning of that term adopted by the district court." *Id.* at 1379.

In *Honeywell*, the patent-in-suit disclosed a fuel filter that was specially made for use with electronic fuel injection systems, *i.e.*, it addressed an "arcing" problem. Although the specification disclosed a fuel filter, the asserted claim was drawn to a "fuel injection system component." The accused products were "quick connects" used to join various components of a fuel injection system together. The district court construed

"fuel injection system component" to mean "a fuel filter" finding that the written description of the patent-in-suit limited the "fuel injection system component" to a fuel filter. On appeal, the Federal Circuit affirmed commenting: "Here, the written description uses language that leads us to the conclusion that a fuel filter is the only 'fuel injection system component' that the claims cover, and that a fuel filter was not merely discussed as a preferred embodiment. On at least four occasions, the written description refers to the fuel filter as 'this invention' or 'the present invention'...." 452 F.3d at 1318. *See also*, *Netcraft Corp. v. eBay, Inc.*, 549 F.3d 1394, 1389 (Fed.Cir.2008)("We agree with Netcraft that use of the phrase 'the present invention' does not 'automatically' limit the meaning of claim terms in all circumstances, and that such language must be read in the context of the entire specification and prosecution history ... For the reasons below, however, we agree with the district court that the common specification's repeated use of the phrase 'the present invention' describes the invention as a whole, ..."). *Cf.*, *Rambus Inc. v. Infineon Techs. AG*, 318 F.3d 1081, 1094 (Fed.Cir.2003)("While clear language characterizing 'the present invention' may limit the ordinary meaning of claim terms, ... such language must be read in context of the entire specification and the prosecution history.").

Turning then to the specification, the first portion of the specification that eBay relies on, '399 patent, col. 1, lines 52-67, appears in the "Background" portion of the specification, and explains in context:

A second conventional message processing system is used in telephone call distribution systems. FIG. 2 is a schematic diagram of an automated call distribution (ACD) system 200 for distributing telephone calls received by the ACD system 200. In the ACD system 200, the only information that is known about the telephone call at the time the telephone call is answered is the type of information that will be discussed during the call (e.g., the caller dials a number for customer service for a particular product line), the identification of the caller (e.g., the caller's telephony system identifier), or both. Such systems are limited because the information content of a telephone call is unknown at the time of call receipt by the ACD system 200. Thus, such content cannot be used in the routing process. As a result, information based on the content of the message, the telephone call, cannot be used to determine the ultimate receiver of the call.

In short, in the prior art ACD system illustrated in Fig. 2:

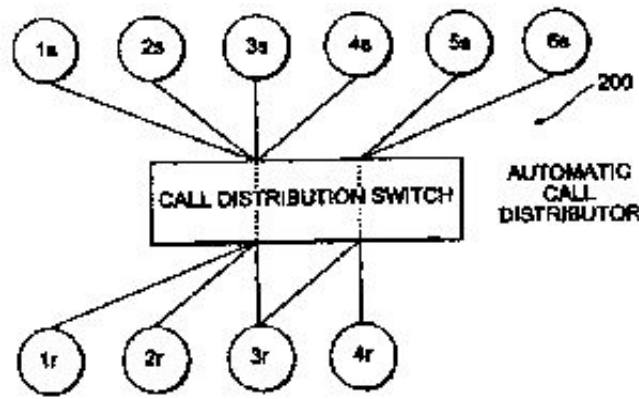

FIG. 2
(PRIOR ART)

FIG. 2

(PRIOR ART)

because these were telephone calls, when the call was answered there was as yet no information about the actual content of the telephone call-the only information known was (1) the general type of information-discerned from the caller having called customer service for a particular product, (2) an identification of the caller, *e.g.*, the caller's telephone identifier, or (3) both. Without knowing the content of the telephone call, content could clearly not be used to further route the call.

The second portion of the specification that eBay relies on, '399 patent, col. 2, lines 55-56, appears under the heading "Summary of the Invention," and explains that "[m]essage content information is not available to conventional ACD systems as described above." Before turning to putting that statement in context, though, it is useful to review the actual disclosure of the '414 and ' 399 patents.

Under the heading "Background of the Invention," the patents explain that:

Generally, a message distribution system distributes information in the form of one or more messages from a message sender to a message receiver. *The message sender combines data representing the information content of the messages into a form that can be transmitted to the message receiver.* A variety of communication media exist over which messages can be transmitted, including telephone, wireless communication systems and computer networks. There are several conventional message distribution systems currently in use for delivering messages from a message sender to a message receiver.

'399 patent, col. 1, lines 19-30 (emphasis added).

The first of the "conventional message distribution systems" described in the "Background" is an automated message routing (AMR) system, illustrated in Fig. 1. The patents explain that this is a point-to-point message distribution system, *i.e.*, messages are distributed by establishing a direct path between a message sender and a message receiver:

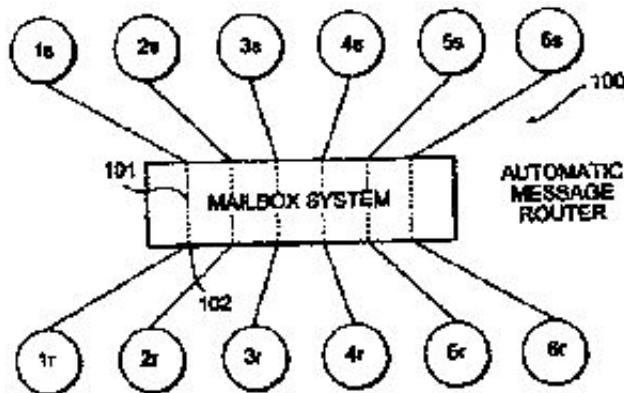

FIG. 1
(PRIOR ART)

FIG. 1

(PRIOR ART)

In that prior art AMR system 100, the patents explain, "a message sender 1s sends a message to a message receiver 1r along a direct path 101. The message receiver 1r is located at logical address 102. Both the message recipient 1r and the route through which the AMR system 100 delivers themes sage are predetermined by the respective addresses of the message sender 1s and the message receiver 1r. Common forms of addresses for the message sender 1s and the message receiver 1r include a dialed telephone number and an identified mailbox address." '399 patent, col. 1, lines 37-46.

The patents further explain, however, that the AMR system is limited "because it does not select the route over which to transmit a message. Rather, the particular route is determined solely by the respective addresses of the message sender and the message receiver." Id. at lines 47-51.

A second of the "conventional message distribution systems" described in the "Back ground" is an automated call distribution (ACD) system 200 illustrated in Fig. 2 above. As noted above, that system is limited to telephone calls, and thus the content of the call is not known when the call is answered.

A third of the "conventional message distribution systems" described in the "Background" is an automated message distribution (AMD) system illustrated in Fig. 3 below. The patents explain that "[c]onventional AMD systems place inbound messages in one or more general-purpose mail boxes that correspond to known pieces of information, and "[i]n an AMD system, the only information known prior to receipt of the message is similar to that of the ACD system described above, i.e., type of information to be discussed and caller identification data." '399 patent, col. 2, lines 1-8.

However, the patents explain, "because the information is in a message format, rather than a telephone call, the rules for message distribution in an AMD system can differ substantially from those for distributing calls in an ACD system. For example, conventional content processing mechanisms, including mail header parsers, addressing parsers, and optical mark recognition (OMR) and optical character recognition (OCR), can add further information to the routing decision." '399 patent, col. 2, lines 8-16.

In Fig. 3 (which although not labeled as prior art, is described as a "schematic of a prior art AMD system," '399 patent, col. 3, line 42):

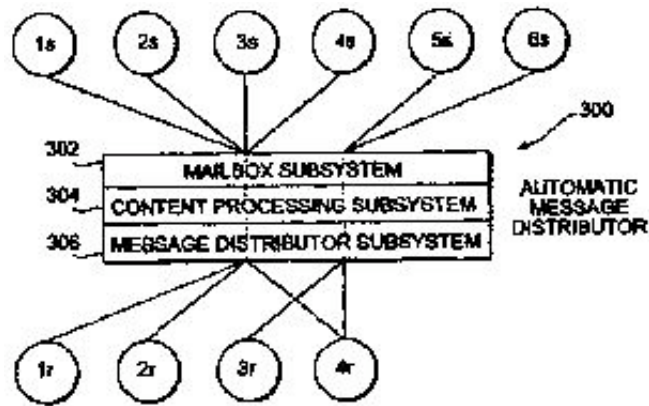

FIG. 3

FIG. 3

the patents explain that "AMD system 300 has a mailbox subsystem 302, a content processing sub system 304 and a message distributor subsystem 306. The mailbox subsystem 304 receives a message from a message sender 1s-6s. The message is received in message format and stored in the mailbox subsystem 302. *The content processing subsystem 304 then derives information from a message stored in the mailbox subsystem 302. This information can be passed to the message distributor subsystem 306 to help distribute the message to an appropriate message receiver 1r-4r.*" '399 patent, col. 2, lines 17-28 (emphasis added).

According to the patents, therefore, deriving content information from received messages, using "conventional content processing mechanisms," and then using that information to appropriately route the messages to the proper recipient, was known in "conventional" AMD systems. "However," the patents explain, "the information stored in conventional mailbox-based AMD systems is not sufficient to determine optimal routing of the mailbox messages to an appropriate message receiver. *This is because no information regarding the priority of the message, the amount of time the message has been in the mailbox subsystem 302, nor the status of the mailbox subsystem 302 potential recipients is monitored in the conventional mailbox system.*" '399 patent, col. 2, lines 27-34 (emphasis added).

The discussion in the patents then turns to the "Summary of the Invention."

Returning to the second portion of the specification that eBay relies on, ' 399 patent, col. 2, lines 55-56, that portion once again explains that "[m]essage content information is not available to conventional ACD systems as described above." That is true because, as discussed above, ACD systems were call processing systems and content of a telephone call is not known at the time a telephone is answered. However, the invention disclosed in the '414 and '399 patents is not an ACD system, but rather an AMD system- *i.e.*, a *message* distribution system of the variety illustrated in Fig. 3. In those AMD systems, according to the foregoing description, content information was known, and such content information could be used to route the messages to the proper recipients.

Putting the portion of the specification that eBay relies on in context, this portion of the specification first explains:

The present invention is an AMD system that is optimized for distributing digitally-encoded messages

(DEMs) received from a number of sources through a computer network and initially stored in one or more distributed message queues (DMQs). The DEMs can be received from a database, over a LAN or WAN or other communication media. Using the present invention, message distribution is optimized according to a set of configurable distribution rules. The message can assume one of a number of manipulatable forms. For example, in the case of facsimile (fax) data, messages can be stored in one of the TIFF, PCX or DCX formats.

'399 patent, col. 2, lines 37-48. Given the foregoing discussion of Fig. 3, it seems clear that "digitally-encoded messages (DEMs)" necessarily include "content information."

The patents go on to explain that:

Unlike conventional AMD systems described above, neither the message receiver's identity nor the route by which the message should be distributed is predetermined.

'399 patent, col. 2, lines 49-52. The reason, of course, is that the invention of the patents-in-suit adds further routing features to the conventional AMD, for example the use of a "distribution rule table (DRT)" that may be used to distribute messages on information other than content.

Nevertheless, the patents further explain in the portion (emphasized) that eBay relies on:

The AMD of the present invention processes information that is received in message format rather than as a telephone call, and therefore can base routing decisions on message content. *Message content information is not available to conventional ACD systems as described above.*

'399 patent, col. 2, lines 51-56 (emphasis added).

eBay points to the above emphasized portion as distinguishing the "present invention" from the "prior art." That is not what the patents are saying at this juncture. It is true that message content was not available on conventional prior art ACD (telephone call) systems, but message content information *was* available on "conventional AMD system 300" of Fig. 3. Nevertheless, as already noted, it seems clear that "digitally-encoded messages (DEMs)" necessarily include "content information," and that is reinforced by the disclosure preceding that which eBay relies on, *i.e.*, "[t]he AMD of the present invention processes information that is received in message format rather than as a telephone call, and therefore can base routing decisions on message content."

On the other hand, it is also clear that routing may be based on other factors. For example, the patents explain that:

The present invention uses a distribution rule table (DRT) in which a set of configurable distribution rules are stored. The distribution rules determine various information regarding the AMD system. Using this information, the message distributor of the present AMD system can route received messages to appropriate message recipients in an optional manner. For example, it may be desirable to evenly distribute messages to available message recipients. In this case, the distribution rules in the table would be chosen such to effectuate even distribution of messages to message recipients.

The DRT operates in conjunction with a resource information table (RIT). The RIT maintains information

corresponding to the availability of resources that are able to process DEMs that are stored in the DMQs. Thus, the present invention uses the DRT in conjunction with the RIT to optimally route incoming DEMs that are initially stored in the DMQs to resources that are able to process the DEMs.

'399 patent, col. 2, line 57-col. 3, line 7.

The third portion of the specification that eBay relies on, col. 3, lines 9-12, explains that "[b]ecause the messages are stored, the present invention can extract content information from the messages for routing purposes that is not available to conventional AMD or ACD systems." Although it is not entirely clear what "content" information *vis-a-vis* a conventional AMD system this portion of the specification is referring to, nonetheless it is clear that the invention is capable of using content information for routing purposes.

As for IDT's contention that the specification "defines" "digitally-encoded messages," the entire paragraph reads:

The present invention provides a mechanism whereby an operator can optimize the distribution of transmitted messages to appropriate receivers in an AMD system. Preferably, the messages are digitally-encoded messages (DEMs). As used herein the term "message" includes any digitally-encoded information that can be transmitted by a sender to a receiver.

'414 patent, col. 4, lines 21-27. It is true that defines "message" and indirectly "digitally-encoded messages." However, it is also clear that is in the context of an AMD system. As discussed above, the patents explain that in an AMD system, "because the information is in a message format, rather than a telephone call, the rules for message distribution in an AMD system can differ substantially from those for distributing calls in an ACD system. For example, conventional content processing mechanisms, including mail header parsers, addressing parsers, and optical mark recognition (OMR) and optical character recognition (OCR), can add further information to the routing decision." '399 patent, col. 2, lines 8-15.

Accordingly, IDT's proposed construction, "[d]igitally-encoded information from a message sender to one or more message receivers," must be rejected. The patents use "digitally-encoded message" in a more limited manner.

With respect to eBay's proposed construction, "[t]he content of a communication from a sender that has been converted into digital form, not simply an identification of the type of information to be communicated," the exclusion "not simply an identification of the type of information to be communicated"-which could be garnered in ACD systems, as the patents point out, from the number called-"the caller dials a number for customer service for a particular product line"-is understood. However, the precise scope of what eBay intends by the "content of a communication," which eBay sometimes refers to as "the actual substantive content of the communication," (Doc No. 95 at 5), is less clear.

Once again, the patents in connection with AMD systems explain that "conventional content processing mechanisms, including mail header parsers, addressing parsers, and optical mark recognition (OMR) and optical character recognition (OCR), can add further information to the routing decision." In context, the patents appear to include "mail header parsers, addressing parsers" *etc.* within the scope of "content information" that is available in an AMD system, and which is not available in an ACD system. Yet, eBay's arguments would seem to exclude the same from "content information." *See* (Doc. No. 95 at 6) ("While a 'digitally-encoded message' *must* contain the actual substantive content of a communication, it *may also*

contain other information, such as mail headers, addresses, and the like.") In light of eBay's arguments, the Court must likewise reject eBay's proposed construction.

Rather, the Court believes that one of ordinary skill in the art, having reviewed the claims and specification of the '414 and '399 patents, would understand "digitally-encoded message" to mean "digitally-encoded information from a message sender to one or more message receivers that includes message content information, for example mail header parsers, addressing parsers, and the like, which may be used in making routing decisions, rather than simply an identification of the type of information (analogous to a caller dialing a number for customer service for a particular product line.)"

c) Conclusion

In view the foregoing, the Court concludes that:

In the context of the '414 and '399 patents, "digitally-encoded message" means "digitally-encoded information from a message sender to one or more message receivers that includes message content information, for example substantive content, mail header parsers, addressing parsers, marks, and the like, which may be used in making routing decisions, rather than simply an identification of the type of information, analogous to a caller dialing a number for customer service for a particular product line."

2. "an automatic message distribution system"

The phrase appears in claims 13 and 21 (and parent claims) of the '414 patent, and claims 1, 2, 15, and 19 of the '399 patent. Claim 15 of the ' 399 patent is representative (the disputed term is in boldface):

15. A method for automatically distributing digitally-encoded messages that are input to **an automatic message distribution system** that includes a resource load containing a plurality of resources, comprising the steps of:

- (a) storing each of said digitally-encoded messages in one or more distributed message queues;
- (b) storing resource information concerning said resources in a resource information table that enables the automatic message distribution system to determine which of said resources is available to a digitally-encoded message stored in said one or more distributed message queues;
- (c) storing a set of routing rules in a distribution routing table that control distribution of said digitally-encoded message to the resources; and
- (d) automatically routing a digitally-encoded message stored in said one or more distributed message queues. [paragraphing added by the parties]

a) The Parties' Proposed Constructions

The parties propose the following constructions:

<i>eBay</i>	<i>IDT</i>
The system that processes information received in message format that can route messages based on message content.	A system that processes information received in message format.

IDT's current proposed construction was advanced after the parties' briefing. Currently, the only substantive difference between the parties' proposed constructions is that eBay adds "that can route messages based on message content." To the extent that IDT previously argued that eBay's proposed construction excluded making routing decisions on factors other than message content, *e.g.*, the availability of resources, eBay clarifies in its sur-reply that "eBay's construction does not provide that the system must make all routing decisions *only* on the basis of message content, to the exclusion of all other considerations." (Doc. No. 95 at 8). However, eBay adds that "thus [the claims as construed] [do] not cover systems that do not use content-based routing." *Id.*

b) Discussion

eBay's proposed construction is taken from the specification, '399 patent, col. 2, lines 51-55, which again, in context, *i.e.*, lines 51-56, provides:

The AMD of the present invention processes information that is received in message format rather than as a telephone call, and therefore can base routing decisions on message content. Message content information is not available to conventional ACD systems as described above.

While it is true, as discussed above, that AMD systems, as described in the '414 and '399 patents, have the capability of making routing decisions based on message content-which ACD systems could not-eBay's arguments seem to gloss over the word "can" (although the word appears in eBay's proposed construction) and seem to contend that routing decisions *must* be made, at least in part, on message content.

The '414 and '399 patents, however, are generally directed to allocating resources to received messages-or, as the specification explains, "[u]sing the present invention, message distribution is optimized according to a set of configurable distribution rules." '399 patent, col. 2, lines 43-45. Although, as the specification also says, the system "can base routing decisions on message content," eBay points to nothing in the claims, specification, or prosecution history of the patents-in-suit that *requires* that routing decisions be made on message content-in addition to other information.

Based on the foregoing, the Court believes that the proper construction of "automatic message distribution system," in the context of the '414 and '399 patents, is "a system that processes information received in message format that is able to route messages based on message content."

c) Conclusion

In view of the foregoing, the Court concludes that:

The phrase "automatic message distribution system" means "a system that processes information received in message format that is able to route messages based on message content."

3. "distribution rule maintenance and access process"

This phrase appears in claim 1 (the disputed term is in boldface) of the '399 patent:

1. An automatic message distribution system, comprising:

a computer;

a message distributor executing on said computer to control distribution of digitally-encoded messages that are input to the automatic message distribution system;

a resource load operatively connected to said message distributor containing resources that process said digitally-encoded messages;

a resource information maintenance and access process operatively connected to said message distributor for storing resource information pertaining to the status of said resources;

a distribution message queue operatively connected to said message distributor to store each of said digitally-encoded messages for distribution; and

a **distribution rule maintenance and application process** connected to said message distributor to store distribution rules for distributing said digitally-encoded messages to said resources from said distribution message queue in accordance with said resource information.

a) The Parties' Proposed Constructions

The parties propose the following constructions:

<i>eBay</i>	<i>IDT</i>
A process that maintains a set of routing rules that control distribution of the digitally-encoded messages and contains routing information required to perform routing, including the users assigned to the distributed message queue, special priority values, and queue threshold values.	No construction necessary.

See Doc. No. 99 at 70 (JCCC Exhibit 1 at 68).

eBay relies on the following portion of the specification for its proposed construction:

The DRT 418 is a distribution rule maintenance and application process that maintains a set of routing rules that control the distribution of DEMs that enter the AMD system 400 and are stored in the DMQ 415 to the resources 1r-6r in the RL 414. The DRT 418 also contains routing information required to perform routing, including the users assigned to the DMQ 415, special priority values and queue threshold values. In the preferred embodiment, the DRT 418 maintains a distributed routing table to store the routing information.

'399 patent, col. 9, lines 58-67. DRT is an acronym for "distribution rule table." (Doc. No. 87 at 25).

b) Discussion

It is not entirely clear why eBay asserts a need to construe this phrase. During briefing, Net2Phone contended that the phrase meant "[a] process that stores distribution rules for distributing digitally-encoded messages to resources from distribution message queues in accordance with information about the resources," which is more or less what the claim language already calls for. (Doc. No. 83 at 14). In the JCCC, IDT, presumably as a result, contends that no construction is necessary.

eBay says that it "is simply following established rules of claim construction in consulting the specification to determine how that express claim limitation should be construed." (Doc. No. 87 at 26). However, the claim calls for a "distribution rule maintenance and application process"-not a DRT or "distribution rule table" which is what the specification describes. Moreover, the claim clearly also provides "connected to said message distributor to store distribution rules for distributing said digitally-encoded messages to said resources from said distribution message queue in accordance with said resource information." '399 patent, col. 13, lines 35-38.

eBay also denies that it is reading limitations into the claim from the preferred embodiment, but rather says that it is simply following the Federal Circuit's rationale in *Curtiss-Wright*, discussed above. In *Curtiss-Wright*, however, the term "adjustable" was ambiguous and, as the Federal Circuit pointed out, the district court's construction of "adjustable" made virtually anything "adjustable." In its sur-reply, (Doc. No. 95 at 10), eBay also quoted from *Phillips* that "[t]he specification is the primary basis for construing the claims," 415 F.3d at 1315, and that "[t]he claims are directed to the invention that is described in the specification; they do not have meaning removed from the context from which they arose." *Id.* at 1316. True, but the Federal Circuit in *Phillips* also began its analysis by reiterating that "[i]t is a 'bedrock principle' of patent law that 'the claims of a patent define the invention to which the patentee is entitled the right to exclude.'" *Id.* at 1312. The Federal Circuit also noted that there was sometimes a fine line between reading limitations from the specification into a claim, and readings claims in light of the specification.

The Federal Circuit explained in *Phillips*, as briefly noted at the outset, that "[h]owever, the line between construing terms and importing limitations can be discerned with reasonable certainty and predictability if the court's focus remains on understanding how a person of ordinary skill in the art would understand the claim terms. For instance, although the specification often describes very specific embodiments of the invention, we have repeatedly warned against confining the claims to those embodiments.... In particular, we have expressly rejected the contention that if a patent describes only a single embodiment, the claims of the patent must be construed as being limited to that embodiment.... That is not just because section 112 of the Patent Act requires that the claims themselves set forth the limits of the patent grant, but also because persons of ordinary skill in the art rarely would confine their definitions of terms to the exact representations depicted in the embodiments." *Id.* at 1323.

eBay also contends that here the quoted portion of the specification is not simply a preferred embodiment, but the only embodiment, citing *Toro Co. v. White Consolidated Indus.*, 199 F.3d 1295, 1301 (Fed.Cir.1999). In *Liebel-Flarsheim Co. v. Medrad, Inc.*, 358 F.3d 898, 907-08 (Fed.Cir.2004), the court explained that "[i]n each of those cases [*Toro* and others], however, there were specific reasons dictating a narrow claim construction beyond the mere fact that the specification disclosed only a single embodiment or a particular structure.... In those cases [including *Toro*], this court interpreted the pertinent claim language narrowly, not merely because the specification did not describe a broader embodiment, but because the specification, claim, or prosecution history made clear that the invention was limited to a particular structure." eBay has made no similar showing here.

Although certainly the specification must be consulted to determine the meaning of disputed terms and phrases in the claims, that does not mean-and neither *Curtiss-Wright* nor any other case that eBay cites, stands for the proposition-that one should or must essentially substitute quoted portions from the specification for the language a patentee has chosen to use in defining her patent property right through the claims. Were that so, the distinction the Federal Circuit has drawn between claims, *i.e.*, "we look to the words of the claims themselves ... to define the scope of the patented invention," *Vitronics Corp. v.*

Conceptronic, Inc., 90 F.3d 1576, 1582 (Fed.Cir.1996), and the specification, *i.e.*, "the purposes of the specification are to teach and enable those of skill in the art to make and use the invention and to provide a best mode for doing so," Phillips, 415 F.3d at 1323, would soon disappear. *See also*, Merrill v. Yeomans, 94 U.S. 568, 570 (1876)(claims are "of primary importance, in the effort to ascertain precisely what it is that is patented."); Markman v. Westview Instruments, Inc., 52 F.3d 967, 980 (Fed.Cir .1995) (*en banc*) ("The written description part of the specification itself does not delimit the right to exclude. That is the function and purpose of claims.").

The Court must thus reject eBay's proposed construction. Inasmuch as eBay does not identify any particular ambiguity in the language of the claim, or any particular disputed meaning, and the Court detects none, no further construction appears to be necessary.

c) Conclusion

In view of the foregoing, the Court concludes that there is no further dispute between the parties *vis-a-vis* this limitation, and no further construction is necessary. If there is, the parties may seek reconsideration.

4. "an automatic message distribution daemon"

This term appears in claim 2 of the '399 patent (the disputed term is in boldface):

2. The automatic message distribution system of claim 1, wherein said message distributor further comprises: **an automatic message distribution daemon** to control distribution of said digitally-encoded messages to said resources.

a) The Parties' Proposed Constructions

The parties propose the following constructions:

<i>eBay</i>	<i>IDT</i>
A continuously-running background process that distributes the messages, and has no controlling terminal.	Continuously-running background process that controls the distribution of digitally-encoded messages to the resources.

See Doc. No. 99 at 71 (JCCC Exhibit 1 at 69).

Again, IDT revised its proposed construction in the JCCC after briefing. Currently, the only substantive difference between the proposed constructions is eBay's requirement "and has no controlling terminal." Although eBay also criticized IDT's prior proposed construction, which included "control the distribution of digitally-encoded messages to the resources," as rendering the remainder of the claim language superfluous. (Doc. No. 87 at 28).

b) Discussion

eBay bases its proposed construction on col. 6, lines 1-11 of the '399 patent, explaining:

Distribution of the DEMs from the main queue to resources in the resource load is a function of the control of the high- and low-priority queues. In the preferred embodiment, such control is performed by a queue controller executing in the message distributor 401, referred to herein as an "AMD daemon" 406. A daemon

is a well-known term in the computer field for a process that is started when a system is bootstrapped and terminates only when the system is shutdown. Daemons are generally considered to run in the background because they have no controlling terminal.

(Doc. No. 87 at 27). eBay says that further support for the "no controlling terminal" limitation can be found in the Microsoft Press Computer Dictionary (2nd ed.1994) at 104. Id. at 27, n. 3. That dictionary defines "daemon" as "[a] program usually associated with UNIX systems that performs a utility (housekeeping or maintenance) function without being requested or even known of by the user. A daemon sits in the background and is called into play only when needed—for example, to help correct an error from which another program cannot recover."

As noted above, the parties agreed that "daemon" meant "[a] continuously running background process." IDT argues that the "parties agreed that the term 'daemon' does not include the negative limitation of 'no controlling terminal' ..." (Doc. No. 92 at 10). eBay says that "[a]lthough the parties agree that a 'daemon' is a 'continuously running background process,' if Net2Phone is of the view that this definition could somehow include a user-controlled process, then the parties do not in fact agree on the meaning and scope of the term 'daemon' itself." (Doc. No. 95 at 11, n. 2).

As IDT correctly notes, IDT's proposed construction follows from the parties' agreed construction of "daemon" and the language of the claim. However, it appears that eBay has had second thoughts about its agreed construction of "daemon."

It is unclear whether the parties vetted the "no controlling terminal" issue when they agreed to the definition of "daemon." IDT implies they did; eBay implies they did not.

In either event, in the Court's view, agreeing to a particular claim construction is in the nature of a stipulation that is not taken lightly. Substantial resources of the parties and the Court rest on the parties honoring their agreements and stipulations despite "second thoughts" or new theories gained in reflection. eBay, for example, has not pointed to anything "new" that was not known at the time the parties agreed to the construction of "demon." In this instance, however, particularly in view of the fact that IDT has not offered any substantive reason why "no controlling terminal" is inaccurate or leads to an erroneous construction, and in light of the patentees' explanation in the specification, the Court is inclined to accept eBay's "no controlling terminal" construction. However, despite that IDT's proposed construction may include some of the subsequent language in the claim, the Court is also inclined to adopt IDT's proposed construction, with a "no controlling terminal" construction added, given that seems overall more accurate, and eBay has given no substantive reason not to adopt that construction.

If this becomes a controlling or decisive issue in the case, the parties may, of course, request the Court to reconsider.

c) Conclusion

In view of the foregoing, therefore, the Court concludes that:

The phrase "an automatic message distribution daemon" in claim 2 of the ' 399 patent means "a continuously-running background process that controls the distribution of digitally-encoded messages to the resources, and has no controlling terminal."

5. "primary user," "primary user list," "secondary user," "secondary user list"

The terms appear in claim 13 of the '414 patent (the disputed terms are in boldface):

13. A method for automatically distributing digitally-encoded messages that are input to an automatic message distribution system that includes a resource load containing a plurality of resources, comprising the steps of:

- (a) storing said digitally-encoded messages in one or more distributed message queues;
- (b) storing resource information concerning said resources in a resource information table that enables the automatic message distribution system to determine which of said resources is available to process a digitally-encoded message stored in said one or more distributed message queues;
- (c) storing a set of routing rules in a distribution routing table that control distribution of said digitally-encoded messages to the resources; and
- (d) automatically routing a digitally-encoded message stored in said one or more distributed message queues
- (e) creating a **primary user list** of at least one **primary user** for each of said one or more distributed message queues;
- (f) storing said primary list in said system configuration file
- (g) creating a **secondary user list** of at least one **secondary user** for each of said one or more distribute message queues; and
- (h) storing said **secondary user list** in said system configuration file;
- (i) storing a count corresponding to the number of digitally-encoded messages stored in the one or more distributed message queues;
- (j) setting a first threshold value that, if reached, indicates that digitally-encoded messages are backing up in said distribution message queue when said count reaches or exceeds said first threshold value;
- (k) setting a second threshold value that, if reached, causes said daemon to use both said **primary user list** and said **secondary user list** to determine where to route said digitally-encoded messages; and
- (l) setting a third threshold value that, if reached, indicates an overflow condition caused by a volume of digitally-encoded messages that is too great for said **primary users** and said **secondary users** to process; and
- (m) storing each of said first, second and third threshold values in said system configuration file.

a) The Parties' Proposed Constructions

<i>Claim Term</i>	<i>eBay</i>	<i>IDT</i>
primary user	A user that has expertise in handling matters contained in the digitally-encoded message assigned to a message queue.	A user who can process a message and is a specialist in a particular area.
primary user list	A list containing entries for all of the primary users.	A list of users who are specialists in a particular area.
secondary user	A user who can process digitally-encoded messages in a message queue, but only in the event that there are no primary users available.	A user who can process a message.
secondary user list	A list containing entries for all of the secondary users, separate from the primary users list.	A list of users who can process messages

See Doc. No. 99 at 71-78 (JCCC Exhibit 1 at 69-76)

b) Discussion

(1) Parties' Arguments

eBay urges that its proposed constructions are "essentially direct quotes from the specification." (Doc. No. 87 at 28). Net2Phone contends that eBay's proposed constructions attempt "to limit the claims to the preferred embodiment." (Doc. No. 83 at 19). eBay responds that "[c]laim 13 of the '414 patent is itself limited to the 'preferred embodiment' that includes primary and secondary users. Indeed, primary and secondary users are *only* discussed in the 'Detailed Description of the Preferred Embodiments,' not in the 'Summary of the Invention.' Thus, eBay has not imported any limitations into the claims from the preferred embodiment. Rather, eBay has simply consulted the specification to construe limitations that expressly appear in the claim. This is exactly what the law of claim construction requires." (Doc. No. 87 at 29) (citing *Curtiss-Wright*, 438 F.3d at 1379-80).

In connection with "primary users," Net2Phone urges that eBay's proposed construction limits "primary users" to those processing messages stored in "the main queue." Net2Phone notes that claim 13 refers to "said *one or more* distributed message queues," and nothing in the claim limits processing messages to those stored in a "main queue." (Doc. No. 83 at 19).

In connection with "secondary users," Net2Phone makes the same argument, noting that eBay's proposed construction limits "secondary users" to users processing messages in "the main queue," while claim 13 refers to "said *one or more* distributed message queues." *Id.* at 19-20.

Net2Phone further urges that eBay's proposed construction of "secondary users" improperly limits the term to "user[s] who can process digitally-encoded messages in a message queue, *but only in the event that there are no primary users available.*" Net2Phone notes that although consistent with the description of the preferred embodiment, "that implementation should not limit the scope of the claims which are more broadly written than the description of the preferred embodiment.... The availability of the primary users does not alone determine when secondary users are tapped to process messages. Other factors or events may lead to the use of secondary users including, the number of messages that can be stored in queue, the time of day when messages received peak, and the rate of message traffic." (Doc. No. 83 at 20).

Net2Phone adds, in its response, that the specification likewise supports its contention that primary and

secondary users are not limited to those processing messages in "the main queue," pointing to col. 5, lines 46-52, which provide:

It would be apparent to those skilled in the art that any number of user classes can be established to fit the needs of a particular implementation of the present invention. For example, a particular implementation of the present invention might have primary, secondary, tertiary, etc. classes of users. Further, *those users may be distributed over any number of queues.*

'414 patent, col. 5, lines 46-52 (emphasis by Net2Phone). Net2Phone urges that "[t]his language shows that primary and secondary users are not limited to handling a main queue, as eBay suggests, but can be 'distributed over any number of queues.'" (Doc. No. 92 at 11-12).

Net2Phone also again urges that eBay's proposed construction limiting secondary users to users who can process messages "but only in the event that there are no primary users available" is wrong, pointing to col. 8, lines 29-45, which provide:

... Considerations in determining appropriate thresholds include the time at which the system experiences peak DEM volume, the size of the peak volume of DEM traffic and how many DEMs can be stored in the DMQ 415 prior to allowing secondary users to process the DEMS.

The number of DEMs in the DMQ 415 can be maintained by the message distributor using a storage register. Initially, the value stored in the storage register is set to the value zero, indicating that no DEMs are stored in the DMQ 415. When a message enters the AMD 400 and is subsequently stored as a DEM in the DMQ 415, the value stored in the storage register is incremented by one. When a DEM is distributed to a resource in the RL 414, the value stored in the storage register is decremented by one. In this way, the storage register maintains a continuous count of the number of DEMs in the DMQ 415.

Net2Phone repeats its earlier argument that the specification thus "indicates that secondary users may be assigned to handle messages depending on a variety of conditions such as the number of messages stored in a message queue, the time of day when the messages received peak, and the rate of message traffic, irrespective of the number of primary users available." (Doc. No. 92 at 12).

Net2Phone also contends that eBay's proposed construction of "primary user list" and "secondary user list" are wrong because they require that "all" users be listed. Net2Phone urges that "these lists are dynamic because users log in and out of the automated message distribution system. 1 ... Therefore, users that are not logged in are not listed. eBay suggests that Net2Phone's construction does not make sense because when a user is not listed, he is invisible to the message distributor and messages could not be routed to him eBay is correct, when a user is not logged in, a message cannot be sent to him. This is one reason why the lists cannot include 'all' users." Id.

eBay in its sur-reply takes a slightly different approach. eBay urges that the "specification makes clear that 'primary users' are separate and distinct from 'secondary users,'" and provides that "[s]econdary users are those who can process the messages stored in the main queue, *but only in the event that there are no primary users available.*" (Doc. No. 95 at 11-12) (quoting '414 patent, col. 5, lines 35-38). According to eBay, "by definition, secondary users are separate and distinct from primary users, as they only process messages in the event that there are no primary users available." (Doc. No. 95 at 12). eBay further asserts that the "specification also makes clear that each of these user classes has its own corresponding user list."

Id. eBay contends that "Net2Phone fundamentally errs in proposing constructions that do not treat primary and secondary users as separate and distinct user classes." In particular, eBay urges that Net2Phone's proposed construction of "secondary user" subsumes a "primary user," and thus Net2Phone's construction of "secondary user list" subsumes the "primary user list." Id. eBay argues that its proposed constructions maintain the distinction between "primary" and "secondary" users.

(2) *Curtiss-Wright*- "Detailed Description of the Preferred Embodiments"

eBay argues in its responsive brief that because primary and secondary users are only discussed in the "Detailed Description of the Preferred Embodiments," not in the "Summary of the Invention." eBay has not imported any limitations into the claims from the preferred embodiment, (Doc. No. 87 at 29) (citing *Curtiss-Wright*, 438 F.3d at 1379-80). That is not what the Federal Circuit said in *Curtiss-Wright*, as discussed above, and is not the law. The purpose of the "Detailed Description of the Preferred Embodiments" is to comply with the written description, enablement and best mode requirements of s. 112(1), as the Federal Circuit explained in *Phillips*. Although certainly there is a relationship between the specification and the claims, as the court also noted in *Phillips*, there is no *carte blanche* to, in essence, replace claim language with language from the specification under the guise of claim construction-and then deny having improperly imported language from the specification into the claims on the rationale that is okay to do so if that language appears in the "Detailed Description of the Preferred Embodiments." Indeed, the Federal Circuit has noted that "[a]lthough a statement's location is not 'determinative,' the location can signal the likelihood that the statement will support a limiting definition of a claim term. Statements that describe the invention as a whole, rather than statements that describe only preferred embodiments, are more likely to support a limiting definition of a claim term.... Statements that describe the invention as a whole are more likely to be found in certain sections of the specification, such as the Summary of the Invention." *C.R. Bard, Inc. v. United States Surgical Corp.*, 388 F.3d 858, 864 (Fed.Cir.2004). Accordingly, simply because the '414 patent describes "primary user," "secondary user" and their respective lists in the "Detailed Description of the Preferred Embodiments" does not give the Court free rein to "construe" the claim by limiting the claim to what was described in the specification.

(3) Claim Language

Beginning as always with the claim language:

13. A method for automatically distributing digitally-encoded messages that are input to an automatic message distribution system that includes a resource load containing a plurality of resources, comprising the steps of:

....

(d) automatically routing a digitally-encoded message stored in said one or more distributed message queues

(e) creating a **primary user list** of at least one **primary user** for each of said one or more distributed message queues;

(f) storing said primary list in said system configuration file

(g) creating a **secondary user list** of at least one **secondary user** for each of said one or more distribute

message queues; and

(h) storing said **secondary user list** in said system configuration file;

....

(k) setting a second threshold value that, if reached, causes said daemon to use both said **primary user list** and said **secondary user list** to determine where to route said digitally-encoded messages; and

(l) setting a third threshold value that, if reached, indicates an overflow condition caused by a volume of digitally-encoded messages that is too great for said **primary users** and said **secondary** users to process; and

(m) storing each of said first, second and third threshold values in said system configuration file.

Net2Phone is correct that nothing in the language of the claim limits the "primary" or "secondary" users to processing messages in the "main queue." And, indeed, as Net2Phone points out, the claim expressly provides "for each of said one or more distributed message queues." There is also nothing in the claim language *per se* that necessarily *requires* eBay's proposed construction of "secondary users" as users who can process messages "but only in the event that there are no primary users available." However, the claim *does* refer to "primary" and "secondary" users—as opposed to, for example, "first users" and "second users," or other language tending to simply differentiate between "users" *per se*. The terms "primary" and "secondary" on their face connote or suggest an ordering, ranking or hierarchy.FN11 Also, the claim calls for "(k) setting a second threshold value that, if reached, causes said daemon to use both said primary user list and said secondary user list to determine where to route said digitally-encoded messages." That further suggests a hierarchy between "primary" and "secondary" users.

FN11. *See e.g.*, MERRIAM-WEBSTER'S COLLEGIATE DICTIONARY (10th ed.1999) at 925 defining "primary," in part, as "first in order of time or development" or "of first rank, importance or value," and at 1054 defining "secondary," in part, as "of second rank, importance or value."

(4) Specification- "main queue"

Turning to the specification, as noted above, eBay relies for its proposed construction on the description of "primary" and "secondary" users. eBay points to col. 5, lines 32-67, which, beginning with line 30 to place the disclosure in context, provide:

In the preferred embodiment, two general classes of users can be assigned to a main queue, primary users and secondary users. Primary users are those that have an expertise in handling matters contained in the DEMs that will be assigned to the main queue. Thus, *primary users can be considered specialists in a particular area. Secondary users are those who can process the messages stored in the main queue, but only in the event that there are no primary users available.* This can occur when, for example, there are so many DEMs entering the main queue that the primary users cannot process all the DEMs, which results in DEMs backing up in the DMQ. DEMs can be routed to secondary users to minimize the impact that the backup will have on DEM processing. Thus, secondary users function as a back up to handle DEMs stored in the main queue when there is no primary user available.

It would be apparent to those skilled in the art that any number of user classes can be established to fit the needs of a particular implementation of the present invention. For example, a particular implementation of the present invention might have primary, secondary, tertiary, etc. classes of users. Further, those users may be distributed over any number of queues.

Each user class has a corresponding user list associated with it. The user list corresponding to a particular class contains entries for each user that is a member of the particular user class. For example, all of the primary users have entries in the user list corresponding to the primary users. This user list can be termed the primary user list. Likewise, any users that have been designated as secondary users of a particular queue have corresponding entries in a secondary users list. A user list for any user class can be empty. The effect of empty users lists is to cause overflow condition threshold limits (described below) to be reached more quickly. For example if the secondary user list is empty, then the second threshold is reached immediately upon the number of DEMs in the DMQ exceeding the first threshold.

First, it is clear from the context that the discussion of "primary" and "secondary" users is in the context of a "preferred embodiment." In that context, the specification explains that "two general classes of users can be assigned to a main queue, primary users and secondary users." What is meant by "main queue" is evident from the immediately preceding paragraphs in the specification, *i.e.*:

There are three types of queues in the preferred embodiment of the present invention, main queues, high-priority queues and low-priority queues. Preferably the queues are related to one another such that the main queue logically contains a high-priority queue and a low-priority queue. For example, referring to FIG. 4, the DMQ 415 is a main queue that logically contains a high-priority queue 420 and a low-priority queue 422. In alternate embodiments of the present invention, there can be multiple levels of priority queues in addition to the high and low-priority queues. The additional priority-level queues provide increased flexibility in message classification. As described below, each of the additional priority-level queues can be named.

Each of the three types of queues can be named. The name is preferably chosen to indicate the purpose of the queue. For example, if the purpose of the main queue is to store DEMs related to auto loans, then the main queue might be named "autoloans," the high-priority queue named "autoloans1" and the low-priority queue named "autoloans2."

'414 patent, col. 5, lines 12-30. Again, that disclosure is in the context of a preferred embodiment.

The specification also explains, in the portion that Net2Phone relies on:

It would be apparent to those skilled in the art that any number of user classes can be established to fit the needs of a particular implementation of the present invention. For example, a particular implementation of the present invention might have primary, secondary, tertiary, etc. classes of users. Further, those users may be distributed over any number of queues.

'414 patent, col. 5, lines 46-52. That, of course, clearly discloses that there may be multiple user classes and "any number of queues." And it is clear that the '414 patent contemplates more than one main queue. *See* Fig. 6A, and accompanying description. Accordingly, and additionally in light of the claim language, eBay's proposed constructions including the limitation "in the main queue" are rejected.

(5) Specification- "primary users"

With respect to the distinction between "primary" and "secondary" users, the specification says that "primary users can be considered specialists in a particular area," while "[s]econdary users are those who can process the messages stored in the main queue, but only in the event that there are no primary users available." '414 patent, col. 5, lines 34-38. Thus, there is a distinction between the two based on expertise. Both parties' proposed constructions capture that distinction. eBay's proposed construction of "primary user" is "a user that has an expertise ..." and eBay's proposed construction of "secondary user" is "a user who can process ...," *i.e.*, one who has the ability to process messages, but does not have the "expertise" of a "primary user." Net2Phone's proposed constructions likewise define "primary user" as "a user who is a specialist ...," and defines "secondary user" as "a user who can process a message ."

Accordingly, it does not appear to the Court that there is any substantive difference between the parties' respective proposed constructions for "primary user" when "the main queue" is excluded, *i.e.*, eBay's proposed construction "a user that has an expertise in handling matters contained in the digitally-encoded messages" is substantively the same as Net2Phone's proposed construction "a user who is a specialist in a particular area." Although eBay includes "in handling matters contained in the digitally-encoded messages," that has not been separately argued, and seems to come from eBay's proposed construction for "digitally-encoded message" which is addressed above.

Thus, the Court adopts Net2Phone's proposed construction for "primary user."

(6) Specification- "secondary users" - "but only in the event that there are no primary users available"

(a) When "there are no primary users available"

Similarly, the parties' core proposed constructions for "secondary user" are substantially the same: eBay's proposed construction "a user who can process digitally-encoded messages" is substantively the same as Net2Phone's proposed construction "a user who can process a message."

The question then becomes whether eBay's addition of "but only in the event that there are no primary users available" is required because that constitutes part of the "invention," as opposed to simply part of the preferred embodiment. The specification, in the above portion, explains when "there are no primary users available," *i.e.*:

This can occur when, for example, there are so many DEMs entering the main queue that the primary users cannot process all the DEMs, which results in DEMs backing up in the DMQ. DEMs can be routed to secondary users to minimize the impact that the backup will have on DEM processing. Thus, secondary users function as a back up to handle DEMs stored in the main queue when there is no primary user available.

'414 patent, col. 5, lines 38-45. In short, when there are too many messages entering the main queue such that the primary users cannot process all of them, messages can be routed to secondary users, and thus secondary users "function as a back up" to the primary users "when there is no primary user available."

(b) Threshold Values

Although Net2Phone is correct that the specification at col. 8, lines 29-45, explains, *inter alia*, that "[c]onsiderations in determining appropriate thresholds include the time at which the system experiences peak DEM volume, the size of the peak volume of DEM traffic and how many DEMs can be stored in the DMQ 415 prior to allowing secondary users to process the DEMS," that does not help Net2Phone.

The specification explains that:

The AMD system 400 also allows one or more queue depth thresholds to be set.... The value corresponds to the number of DEMs that are stored in the DMQ 415. The AMD daemon 406 will take various actions if the number of DEMs stored in the DMQ 415 reaches and/or exceeds any queue depth threshold.

There are three queue depth thresholds in the preferred embodiment. The first threshold is a warning threshold, which informs the AMD daemon 406 that DEMs are backing up in the DMQ 415. The second threshold informs the system that the users currently processing DEMs in the DMQ 415 are unable to keep up with the current DEM volume of DEM traffic. The third threshold is an overflow threshold that informs the AMD daemon 406 that the current DEM volume is too large for the current set of primary and secondary users to process.

'414 patent, col. 8, lines 10-26. The portion that Net2Phone relies on then follows. In context, "considerations" such as time, peak volume *etc.* are used in "determining appropriate thresholds," namely those discussed above. The system then takes certain actions depending on which threshold is reached. The specification explains:

If the number of DEMs in the DMQ 415 reaches the warning threshold, a message indicative of this condition is written to a system log file and/or printed on a system printer. The message indicates that the DEM traffic is sufficient to cause a backlog of DEMs. If the number of DEMs reaches the second threshold, the eligible user list is augmented by adding secondary users for the DMQ 415 to handle the overflow of DEMs in the DMQ 415. If the number of DEMs stored in the DMQ 415 reaches the overflow threshold, then a message indicative of this condition is written to a system log file and/or a system printer. An overflow condition indicates that the number of DEMs entering the AMD system 400 is too great to be handled by the primary and secondary users currently assigned to process the incoming messages. It would be apparent to those skilled in the art that other actions are possible upon reaching and/or exceeding a particular threshold value. For example, messages can be moved from one queue to another (less busy queue) either manually or automatically, when a particular threshold is reached.

'414 patent, col. 8, lines 46-65.

Claim 13 similarly provides:

13. A method for automatically distributing digitally-encoded messages that are input to an automatic message distribution system that includes a resource load containing a plurality of resources, comprising the steps of:

....

(e) creating a primary user list of at least one primary user for each of said one or more distributed message queues;

(f) storing said primary list in said system configuration file

(g) creating a secondary user list of at least one secondary user for each of said one or more distribute message queues; and

(h) storing said secondary user list in said system configuration file;

(i) storing a count corresponding to the number of digitally-encoded messages stored in the one or more distributed message queues;

(j) *setting a first threshold value that, if reached, indicates that digitally-encoded messages are backing up in said distribution message queue when said count reaches or exceeds said first threshold value;*

(k) *setting a second threshold value that, if reached, causes said daemon to use both said primary user list and said secondary user list to determine where to route said digitally-encoded messages; and*

(l) *setting a third threshold value that, if reached, indicates an overflow condition caused by a volume of digitally-encoded messages that is too great for said primary users and said secondary users to process; and*

(m) *storing each of said first, second and third threshold values in said system configuration file.* (emphasis added)

Thus, not only according to the specification, but according to claim 13 as well, there are three threshold values. The parties agreed that "threshold value" means "[a] defined number of digitally-encoded messages in the distributed message queue." The first threshold, in terms of the disclosure, indicates that the number of DEMs in DMQ 415 are backing up. Claim 13 does not expressly say what happens if that threshold is reached-although the claim calls for creation of primary and secondary user lists. The specification says that "[i]f the number of DEMs in the DMQ 415 reaches the warning threshold, a message indicative of this condition is written to a system log file and/or printed on a system printer. The message indicates that the DEM traffic is sufficient to cause a backlog of DEMs." '414 patent, col. 8, lines 46-49.

According to claim 13, reaching the second threshold "causes said daemon to use both said primary user list and said secondary user list to determine where to route said digitally-encoded messages." The specification explains that "[t]he second threshold informs the system that the users currently processing DEMs in the DMQ 415 are unable to keep up with the current DEM volume of DEM traffic." '414 patent, col. 8, lines 20-23. The specification also explains that "[i]f the number of DEMs reaches the second threshold, the eligible user list is augmented by adding secondary users for the DMQ 415 to handle the overflow of DEMs in the DMQ 415." '414 patent, col. 8, lines 50-53.

And, the specification also earlier explained that:

Secondary users are those who can process the messages stored in the main queue, but only in the event that there are no primary users available. *This can occur when, for example, there are so many DEMs entering the main queue that the primary users cannot process all the DEMs, which results in DEMs backing up in the DMQ. DEMs can be routed to secondary users to minimize the impact that the backup will have on*

DEM processing. Thus, secondary users function as a back up to handle DEMs stored in the main queue when there is no primary user available.

'414 patent, col. 5, lines 35-45 (emphasis added). Thus, although "considerations" such as time, peak volume *etc.* may be used in "determining appropriate thresholds," there is nevertheless a ranking or hierarchy between "primary" and "secondary" users. The "secondary" users, as the specification explains, serve as a backup to the "primary" users-which, of course, is in keeping with the fundamental distinction that the parties agree on, namely "primary users" have expertise in handling messages in a particular area, while "secondary users" have the capability of handling such messages, but lack the expertise of "primary users." And, claim 13 likewise says that reaching the second threshold "causes said daemon to use both said primary user list and said secondary user list."

The third threshold is described in the specification as "an overflow threshold that informs the AMD daemon 406 that the current DEM volume is too large for the current set of primary and secondary users to process." '414 patent, col. 8, lines 23-26, 57-60. Claim 13 similarly calls for "setting a third threshold value that, if reached, indicates an overflow condition caused by a volume of digitally-encoded messages that is too great for said primary users and said secondary users to process."

The specification also discloses:

Although there are three thresholds in the preferred embodiment of the present invention, any number of thresholds, including no thresholds, can be used in a particular implementation of the present invention. Each threshold provides an additional warning of a queue overflow condition. An action can be defined for each threshold. The action is taken when the numbers of DEMs stored in a particular queue reaches or exceeds the particular threshold for which it is defined. In an embodiment using no thresholds, there is no warning of a queue overflow condition.

'414 patent, col. 8, line 66-col. 9, line 9. Thus, there may be more than three thresholds, and actions can be defined for each threshold, and there may be no thresholds at all. In claim 13, however, three thresholds are defined, and the action for reaching the second threshold is likewise defined, *i.e.*, doing so "causes said daemon to use both said primary user list and said secondary user list to determine where to route said digitally-encoded messages."

Accordingly, Net2Phone's reliance on the disclosure at col. 8, lines 29-34 in urging that factors or events other than the unavailability of a primary user, such as the number of messages stored in a queue, the time of day when messages received peak, rate of message traffic, *etc.*, may lead to use of secondary users, is misplaced. Although such factors may be used in setting the various thresholds, neither the claim language nor the specification suggest or require that the hierarchical relationship between "primary users" and "secondary users" is changed.

(c) Resolution

As the Federal Circuit recently noted in *Princo Corp. v. U.S. Int'l Trade Comm'n*, --- F.3d ----, ---- (Fed.Cir.2009), a case involving patent misuse issues, although some of the court's cases have been perceived by patent litigants as limiting claims to disclosed embodiments (the court cites *Toro Co. v. White Consol. Indus., Inc.*, 199 F.3d 1295 (Fed.Cir.1999); *Wang Labs., Inc. v. Am. Online, Inc.*, 197 F.3d 1377 (Fed.Cir.1999), as two examples), while other cases have been perceived as cautioning against improperly

importing limitations from the specification into the claims (the court cites *Comark Commc'ns, Inc. v. Harris Corp.*, 156 F.3d 1182, 1186 (Fed.Cir.1998); *Electro Med. Sys., S.A. v. Cooper Life Scis., Inc.*, 34 F.3d 1048, 1054 (Fed.Cir.1994), as two examples), the Federal Circuit reiterated that the proper role of the specification in resolving claim construction disputes was addressed *en banc* in *Phillips*.

In *Phillips*, the Federal Circuit explained, once again, that "the line between construing terms and importing limitations can be discerned with reasonable certainty and predictability if the court's focus remains on understanding how a person of ordinary skill in the art would understand the claim terms. For instance, although the specification often describes very specific embodiments of the invention, we have repeatedly warned against confining the claims to those embodiments.... To avoid importing limitations from the specification into the claims, it is important to keep in mind that the purposes of the specification are to teach and enable those of skill in the art to make and use the invention and to provide a best mode for doing so.... One of the best ways to teach a person of ordinary skill in the art how to make and use the invention is to provide an example of how to practice the invention in a particular case. Much of the time, upon reading the specification in that context, it will become clear whether the patentee is setting out specific examples of the invention to accomplish those goals, or whether the patentee instead intends for the claims and the embodiments in the specification to be strictly coextensive." 415 F.3d at 1323 (paragraphing and citations omitted). *See also*, *MBO Labs., Inc. v. Becton, Dickinson & Co.*, 474 F.3d 1323, 1330 (Fed.Cir.2007) ("The patentee here has clearly indicated via the specification and the prosecution history that the invention provides, as an essential feature, immediate needle safety upon removal from the patient. It is therefore appropriate to construe the claims so as to ensure that they, too, require that feature."); *On Demand Mach. Corp. v. Ingram Indus., Inc.*, 442 F.3d 1331, 1340 (Fed.Cir.2006) ("The Ross specification repeatedly reinforces its usage of the term 'customer' as the retail consumer.... Although we agree with the district court that the Ross invention does not concern itself with whether the 'customer' reads the book or obtains it for resale, the focus of the Ross patent is immediate single-copy printing and binding initiated by the customer and conducted at the customer's site. The district court's definition of 'customer' cannot eliminate these constraints in order to embrace the remote large-scale production of books for publishers and retailers.").

In a nutshell, each case must be decided on the particular claims and specification before the Court. In some instances, the specification may refer to something as an "essential feature" of the invention. In others, repeated usages of a term may be instructive. In all events, though, and once again, the Federal Circuit has consistently instructed that "[u]ltimately, the interpretation to be given a term can only be determined and confirmed with a full understanding of what the inventors actually invented and intended to envelop with the claim. The construction that stays true to the claim language and most naturally aligns with the patent's description of the invention will be, in the end, the correct construction." *Phillips*, 415 F.3d at 1316 (quoting *Renishaw*, 158 F.3d at 1250) (citations omitted)).

The specification here, once more, says that "primary users can be considered specialists in a particular area," while "[s]econdary users are those who can process the messages stored in the main queue, but only in the event that there are no primary users available." Although the express language of claim 13 does not require that "primary users" have "expertise" in a particular area, or, according to Net2Phone's proposed construction, be one "who is a specialist," Net2Phone's proposed constructions acknowledge that there is some level of knowledge, skill, proficiency or the like that distinguishes those that are assigned to "primary user lists" from those that are assigned to "secondary user lists." Thus, Net2Phone adopts *part of* the distinction the specification draws between "primary" and "secondary" users, but rejects the rest, namely "only in the event that there are no primary users available." As a result, while the specification as a whole teaches that there is a hierarchical relationship between "primary" and "secondary" users, Net2Phone's

proposed construction of "secondary user" does not provide for any ranking or ordered relationship between "primary" and "secondary" users, despite acknowledging that "primary users" are "specialists," while "secondary users" are not. Under Net2Phone's proposed constructions, "secondary users" could be assigned to process messages regardless of whether "primary users" were available. But that is not what the specification teaches.

Moreover, a reasonable reading of claim 13, especially but not solely limitation (k):

(k) setting a second threshold value that, if reached, causes said daemon to use both said primary user list and said secondary user list to determine where to route said digitally-encoded messages; and

in the context of the claim as a whole, and in light of the specification, preserves the same hierarchical structure between "primary" and "secondary" users described in the specification.

Once again, the parties agree that "threshold value" means "[a] defined number of digitally-encoded messages in the distributed message queue." Limitation (k), in light of that agreement, is read "setting a second threshold value [*i.e.*, a defined number of digitally-encoded messages in the distributed message queue] that, if reached, causes said daemon to use both said primary user list and said secondary user list to determine where to route said digitally-encoded messages." As noted above, the specification explains that "[t]he second threshold informs the system that the users currently processing DEMs in the DMQ 415 are unable to keep up with the current DEM volume of DEM traffic." '414 patent, col. 8, lines 20-23. The specification then explains that "[i]f the number of DEMs reaches the second threshold, *the eligible user list is augmented by adding secondary users* for the DMQ 415 to handle the overflow of DEMs in the DMQ 415." '414 patent, col. 8, lines 50-53 (emphasis added). The term "augmented" connotes "increased" or "enlarged" which is confirmed with the next explanatory phrase "by adding secondary users." FN12

FN12. Figs. 6A and 6B are described as "a tabular representation of a queue configuration according to a preferred embodiment of the present invention" and "a partial configuration file corresponding to the configuration illustrated in FIG. 6A." '414 patent, col. 3, lines 51-56. The corresponding description explains that "users" may be included as "primary users" in some queues and "secondary users" in other queues depending on their "expertise":

An example of a queue configuration for a financing center is illustrated in FIG. 6A. A portion of a corresponding configuration file is illustrated in FIG. 6B. Referring to FIGS. 6A and 6B, four queues are illustrated. The queues are named "autoloans", "homeloans," "studentloans" and "refinance." The purpose of each of the queues is given in the figure as are the names of the high-and low-priority queues. Note that the names of the queues are preferably chosen to closely correspond to the purpose of the queues.

Some additional comments are provided to help explain the figures. Ed, Pat and Dave only process auto loans. They are therefore listed as primary users of the "autoloans" queue, and not listed as secondary users of any queue. Mary and Fred are home loan specialists. Mary and Fred also know how to process home loan refinances. They are therefore listed as primary users of the "homeloans" queue and secondary users of the "refinance" queue to help process home loan refinances should the "refinance" queue back up. Charlie, Mark and Robert only process student loans. They are therefore listed only as primary users of the "student loans" queue. Sue is a refinance specialist, but she also has years of experience processing other forms of loans. She is therefore listed as a primary user of the "refinancing" queue, and a secondary user of the "autoloans,"

"homeloans" and "studentloans" queues. Joe is similar to Sally, but has more experience with refinancing. Therefore, Joe appears as a primary user in the "refinance" queue, whereas Sally is a secondary user. Bill specializes in home and refinance loans. He is therefore listed as a primary user in the "homeloans" and "refinancing" queues. Because he has sufficient knowledge of student loan processing, he is listed as a secondary user of the "studentloans" queue.

Note that FIG. 6B is a portion of the configuration file that corresponds to the queue configuration of FIG. 6A. The configuration file illustrates the fields required to describe the "autoloans," "studentloans" and "homeloans" main queues of FIG. 6A. It would be apparent to those skilled in the art how to complete the configuration file illustrated in FIG. 6B to include the "refinance" main queue or to extend the configuration file to include other queues. Note that at least one primary user is required for each main queue. There can be any number of additional to primary users. There can be any number of secondary users, including no secondary users. Default values for the various parameters (including threshold, bonus values, sleep time, etc.) can be set by a system administrator or operator.

'414 patent, col. 11, lines 17-62. Although couched in terms of a "preferred embodiment," that disclosure nevertheless provides insight to the patentees' view of "primary users" and "secondary users." Thus, Net2Phone's proposed construction of "primary" and "secondary" users draws a distinction between the two classes of users based on expertise (a "primary user" is "a user who is a specialist ...," while a "secondary user" is "a user who can process a message"), which Net2Phone, by proposing that construction, presumably agrees is implicitly required by the claim language when the claim is read in light of the specification (although not required by the *express* language of claim 13). At the same time, however, Net2Phone's proposed constructions do not capture, and through Net2Phone's arguments, specifically reject, the hierarchical or rank and order relationship between the two classes of users, despite that such relationship likewise is reasonably required—here to some extent because of the claim language itself, but especially so when claim 13 is read in light of the specification. Under Net2Phone's proposed construction, messages could be routed to "secondary" users for a variety of reasons (which remains true when "primary users" are ranked or ordered in terms of preference for their expertise or that they are a "specialist," over "secondary users"), but Net2Phone's proposed construction departs from the teachings of the specification by allowing routing to "secondary users" regardless whether "primary" users (and their expertise) are available. Net2Phone, though, has pointed to no disclosure that would support that construction, and, on independent review, the Court finds none. The specification as a whole, insofar as the current record reveals, simply provides no support for Net2Phone's proffered construction. As noted above, although Net2Phone refers to the portion of the specification discussing "thresholds," that portion of the specification does not teach or suggest that the hierarchical or rank or order relationship between "primary" and "secondary" users is removed or eliminated when "thresholds" are established. As already noted, "considerations" such as time, peak volume *etc.* may be used in "determining appropriate thresholds," there is nevertheless a ranking or hierarchy between "primary" and "secondary" users. The "secondary" users, consistently throughout the disclosure in the specification, serve as a backup to the "primary" users.

More than a preferred embodiment, the hierarchical or rank or order relationship between "primary" and "secondary" users follows from several consistent sources, not only in the claim language, but the specification as well, namely: the choice of "primary" and "secondary" to differentiate the users in both the claims and the specification (as opposed more broadly to "first" and "second"), the distinction between the

two classes of users based on "expertise" or that one is a "specialist" in an area, the description of the fundamental operation of the system *vis-a-vis* "primary" and "secondary" users that goes beyond merely one example, and a reasonable interpretation of the claim language that incorporates the hierarchical or rank or order distinction between "primary" and "secondary" users. *See e.g.*, *Finisar Corp. v. DirecTV Group, Inc.*, 523 F.3d 1323, 1330 (Fed.Cir.2008)("The hierarchical indices recited later in the claims for 'referencing data' in the information database actually confirm, rather than refute, that the claimed method must include search and retrieval features. Such hierarchical indices facilitate the search and retrieval of data from the information database. Thus the claims envision a more specific 'information database' than provided by the district court's construction."-construing "information database" as "a collection of computerized information which can be accessed and searched, and from which selected information can be retrieved, and where the search and retrieval capabilities are at least as specific as those of the hierarchically arranged set of indices."). Consequently, the Court is not persuaded that one of ordinary skill in the art would view "secondary user" as Net2Phone proposes. Net2Phone's proposed broader construction finds no "grounding" in the language of the claims or the specification, and is simply not consistent with the teachings of the specification or the claim language.

Additionally, the Federal Circuit in *Phillips* explained that the focus is "on how the patentee used the claim term in the claims, specification, and prosecution history, ..." *Phillips*, 415 F.3d at 1321. *See also, Every Penny Counts, Inc. v. American Express Co.*, --- F.3d ---- (Fed.Cir.2009) ("The portion of the specification quoted above tells us what 'excess cash' means in the context of the patent claim: 'excess cash' is what is left over after the merchant subtracts the price of the items the consumer wishes to buy from the cash the consumer tenders to complete the sale."). The term "secondary users" is used consistently throughout the specification to refer to users that serve as a backup to handle messages when there is no "primary users" available.

Thus, the Court believes that one of ordinary skill in the art, having reviewed the specification and claims of the '414 patent, would construe "secondary user" as "a user who can process a message and who functions as a back up to handle messages when there is no primary user available."

With respect to the "lists," the Court agrees with Net2Phone that such lists need not contain "all" primary or secondary users. The Court thus rejects eBay's proposed construction. On the other hand, there is no need to repeat the construction of "primary user" and "secondary user" when construing the "lists." Accordingly, the Court construes "primary user list" as "a list of primary users," and "secondary user list" as "a list of secondary users."

c) Conclusion

In view of the foregoing, the Court concludes that, in claim 13 of the '414 patent:

"Primary user" means "a user who is a specialist in a particular area."

"Secondary user" means "a user who can process a message and who functions as a back up to handle messages when there is no primary user available."

"Primary user list" means "a list of primary users."

"Secondary user list" means "a list of secondary users."

V.

U.S. Patent No. 6,275,490

The '490 patent, entitled "Method and Apparatus for Establishing Communications From Browser Application," issued on August 14, 2001 to Shane D. Mattaway, Glenn W. Hutton, Bradley D. Noe, Steven M. Hancock and Park A. Pietras, from Application No. 08/915,034, filed on August 20, 1997. That application claims priority to Provisional Patent Application No. 60/024,251 filed August 21, 1996. The '490 patent, on its face, indicates that it was assigned to NetSpeak Corporation. It is understood that Net2Phone is the current owner of the patent.

A. Overview

The '490 patent "relates, generally, to data processing systems and telecommunication systems, and, more specifically, to a technique for establishing communications from browser application." '490 patent, col. 1, lines 64-67. According to the abstract:

A technique for initiating communications from a web browser to a destination on either a packet-switched data network or a circuit-switched communication network includes a communication utility capable of interacting with a browser utility and responsive to address information obtained from a website for establishing a communication link with the website with the other destination defined by the address information. In one embodiment, the address information may comprise either an Internet protocol address, an E-mail address, or a traditional telephone number. The communication utility further enables sharing of URL data so that once a communication link is established, the parties may examine the same website pages simultaneously while communicating over a point-to-point communication link.

Net2Phone says that the '490 patent is drawn to "click-to-call" technology which "allows web users to click on an icon or link in a web browser to make a telephone call." (Doc. No. 83 at 7). Net2Phone alleges that eBay infringes the patent "by allowing its users to contact sellers by clicking on 'Skype Me!' buttons on a given seller's web pages." *Id.*

The Court will discuss the '490 patent further below in connection with resolving the parties' claim construction disputes.

B. Agreed Terms

The parties agree that the following terms have the following meanings:

<i>Claim Term</i>	<i>Agreed Construction</i>
"a computer telephony communication utility"	A program used on a computer to initiate a real-time audio communication connection.
"a computer telephony program code"	rProgram code to establish a real-time audio communication connection.
"destination identified by address information"	A network address on a packet-switched data network or terminating apparatus on a circuit-switched network, identified by the address information.
"destination specified by address"	

information"	
"computer usable medium"	A tangible medium for storing computer-readable data.
"browser process"	A software application that provides a graphical user interface for locating and exploring websites on the worldwide web.
"browser program code"	
"terminating apparatus"	A terminating device on a circuit-switched communication network capable of receiving a call.
"a computer telephony communication utility associated with the browser process"	A computer telephony application and the web browser process both executing locally on the user's computer system.

See Doc. No. 99 at 79-86 (JCCC Exhibit 1 at 77-84).

C. The Asserted Claims

Net2Phone asserts claims 1, 6, 8, 12 and 18:

1. A method for establishing real-time audio communications between a process executing on a computer system coupled to a packet-switched network and an information source coupled to either a packet-switched data network or terminating apparatus on a circuit-switched communication network, the method comprising:

A. retrieving, with a browser process executing on the computer system, address information usable in establishing a real-time audio communication connection with a destination;

B. supplying the address information from the browser process to a computer telephony communication utility associated with the browser process; and

C. initiating with the computer telephony communication utility a real-time audio communication connection with the destination identified by the address information.

6. The method of claim 1 wherein the address information is in the form of hypertext markup language (HTML).

8. The method of claim 7 wherein step A.1 further comprises:

A.1.1 selecting the address information with a pointing device from a user interface associated with the browser process.

12. The method of claim 1 further comprising:

D. establishing a communication link with the destination designated by the address information.

18. A computer program for use with a computer system operatively coupled to a computer network, the computer system capable of executing one or more processes, the computer program comprising a computer usable medium having computer readable program code embodied in the medium, the program code comprising:

A. browser program code configured to obtain address information usable in establishing a real-time audio communication connection with a destination;

B. computer telephony program code for establishing a real-time audio communication connection with the destination, the destination comprising an address on a packet-switched network or terminating apparatus on a circuit-switched communication network;

C. program code, responsive to the browser program code, for supplying to the computer telephony program code the address information; and

D. program code for initiating execution of the computer telephony program code for establishing a real-time audio communication connection with the destination specified by the address information.

D. Disputed Terms and Phrases

1. "address information"

The term appears in claim 1, 6, 8, 12 and 18. The parties deem claim 1 as representative (the disputed term is in boldface):

1. A method for establishing real-time audio communications between a process executing on a computer system coupled to a packet-switched network and an information source coupled to either a packet-switched data network or terminating apparatus on a circuit-switched communication network, the method comprising:

A. retrieving, with a browser process executing on the computer system, **address information** usable in establishing a real-time audio communication connection with a destination;

B. supplying the **address information** from the browser process to a computer telephony communication utility associated with the browser process; and

C. initiating with the computer telephony communication utility a real-time audio communication connection with the destination identified by the **address in formation**. (emphasis added)

a) The Parties' Proposed Constructions

The parties propose the following constructions:

<i>eBay</i>	<i>IDT</i>
An Internet Protocol address, an E-mail address or a telephone number.	Information that a telephone communication utility will use to establish a communication with a destination.

See Doc. No. 99 at 87 (JCCC Exhibit 1 at 85).

b) Discussion

Beginning once again and always with the claim language, nothing in the claim language *per se* counsels in favor of one construction or the other. However, claim 1 *does* require "initiating with the computer telephony communication utility a real-time audio communication connection *with the destination identified*

by the address information." (emphasis added)

Thus, turning to the specification, eBay's proposed construction is based on the following statement in the specification:

Contained on webpage 302 is address information, i.e. an Internet protocol address, an E-mail address or a telephone number, or other information which may be stored in any number of forms including an HTML tag.

(Doc. No. 87 at 38) (quoting '490 patent, col. 9, line 66-col. 10, line 2). eBay points out that "*i.e.*" stands for the Latin term *id est*, meaning "that is." eBay relies in part on *Abbott Labs. v. Novopharm Ltd.*, 323 F.3d 1324, 1327, 1330 (Fed.Cir.2003), in urging that the specification thus defines "address information."

In *Abbott*, the specification of the patent-in-suit explained:

the "co-micronization of fenofibrate and a solid surfactant (i.e., the micronization of an intimate mixture of fenofibrate and a solid surfactant) makes it possible to improve the bioavailability of the fenofibrate to a significantly greater extent than that which would be achieved either by adding a surfactant [to fenofibrate], or by micronizing the fenofibrate on its own, or by intimately mixing the separately micronized fenofibrate and surfactant."

323 F.3d at 1327. The district court concluded that claims thus could not be construed to include "mixtures obtained by adding a surfactant to fenofibrate, or micronizing fenofibrate by itself, and/or mixing separately micronized fenofibrate and surfactant." *Id.* The Federal Circuit agreed: "Had that term not been explicitly defined in the '726 patent specification, we might well agree with the appellants that that term could simply mean 'micronized with or together' and would not necessarily exclude the presence of ingredients not specifically recited in the claim. However, the phrase 'co-micronization of fenofibrate and a solid surfactant' is in fact explicitly defined at column 1, lines 35-38, of the '726 patent, as 'micronization of an intimate mixture of fenofibrate and a solid surfactant.' Hence, this is a case in which the patentee has 'chosen to be his own lexicographer,' and the district court did not err by reading the patentee's definition from the specification into the claim." 323 at 1330.

Net2Phone argued in its opening brief that "other information" in the quoted portion of the '490 patent specification indicated that "address information" encompasses "all types of information usable in establishing a communication with a destination." (Doc. No. 83 at 28). eBay in response notes that disregards the grammar expressed in the sentence. That is, eBay points out that in the phrase "an Internet protocol address, an E-mail address or a telephone number, or other information," "or other information" does not refer to "address information," but rather other information that may be contained on a webpage. In other words, "[c]ontained on webpage 302 is [1] address information, i.e. an Internet protocol address, an E-mail address or a telephone number, or [2] other information which may be stored in any number of forms including an HTML tag." (Doc. No. 87 at 39). eBay notes that to read the sentence as Net2Phone does, the sentence would have to be rewritten "[c]ontained on webpage 302 is address information, i.e. an Internet protocol address, an E-mail address, a telephone number, or other information which may be stored in any number of forms including an HTML tag." *Id.*

Net2Phone responds that "eBay's citations to the case law [i.e., *Abbott*], however, are irrelevant because they would only support eBay's proposition only if there were no other disclosure in the specification as to

the scope of 'address information,' " (Doc. No. 92 at 13-14) (citing *Pfizer, Inc. v. Teva Pharms. USA, Inc.*, 429 F.3d 1364, 1373-74 (Fed.Cir.2005)), urging that the Federal Circuit held that " *i.e.*" did not define the term "saccharides" because the remainder of the specification gave the term a broader scope. Net2Phone urges that "[i]n any case, the Background of the Invention removes any ambiguity regarding whether other information is included in 'address information' by providing that 'other information' can be address information to the extent that it is retrieved from a website and used to establish a communication with a destination." (Doc. No. 92 at 14) (citing '490 patent, col. 3, lines 39-44).

In its sur-reply, eBay urges contends that Net2Phone's reliance on *Pfizer* is misplaced because here, unlike in *Pfizer*, there is no disclosure of a broader intended meaning. eBay urges that "Net2Phone has not and cannot point to a single instance in the intrinsic evidence where 'address information' comprises something other than an internet protocol address, an email address or a telephone number." (Doc. No. 95 at 14-15).

The Court agrees with eBay. First, eBay is correct in parsing the sentence, according to punctuation and grammar: "[c]ontained on webpage 302 is [1] address information, i.e. an Internet protocol address, an E-mail address or a telephone number, or [2] other information which may be stored in any number of forms including an HTML tag." Or, using ellipses: "[c]ontained on webpage 302 is [1] address information, ... or [2] other information which may be stored in any number of forms including an HTML tag." In *Finisar Corp. v. DirecTV Group, Inc.*, 523 F.3d 1323, 1336 (Fed.Cir.2008), the Federal Circuit, in discussing the doctrine of the last antecedent and the corollary rule of punctuation, commented that "[t]herefore, to avoid slipping into a realm of ambiguity that could render jury verdicts wholly unreviewable, this court imputes an understanding of English grammar and usage to the jury. Moreover this court consults the overall context of the passage." The court also, though, noted that rules of grammar and punctuation "are more guidelines than absolute rules." *Id.*

Nevertheless, the grammatical construction becomes clearer in the context of the specification. The paragraph in which the subject sentence lies, begins: "FIG. 3 illustrates conceptually the inventive process of the present invention." '490 patent, col. 9, lines 61-62. Fig. 3 illustrates:

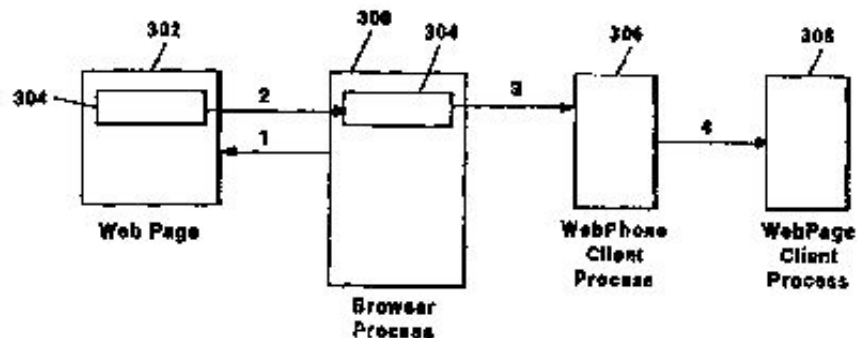

Figure 3

Figure 3

The paragraph continues: "First, a browser utility process 300 executing on one of the same computer

systems as WebPhone client 232 of FIG. 2B accesses a webpage 302 residing on web server 260 of FIG. 2B, as illustrated by step 1." '490 patent, col. 9, lines 62-66. The reference to "step 1" refers to arrow 1 in Fig. 3. Fig. 2B illustrates:

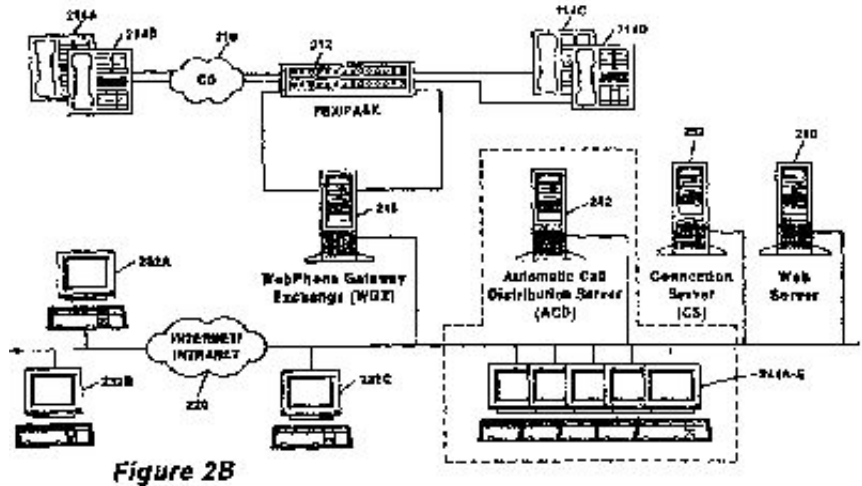

Figure 2B

The specification then explains that:

Contained on webpage 302 is address information, i.e. an Internet protocol address, an E-mail address or a telephone number, or other information which may be stored in any number of forms including an HTML tag. The address information is selected by the user of browser process 300, typically with a pointing device by clicking a graphic representation of the data on the webpage, as illustrated by step 2. The address information is then supplied to WebPhone client process 306, as illustrated by step 3. If the WebPhone client process is already executing, the browser process 300 does not need to launch the WebPhone client process, otherwise the process 300 launches the WebPhone client process. Having obtained the address information, the WebPhone client process 306, upon instruction from the user or automatically upon receipt of the address information from browser process 300, attempts to establish a direct, point-to-point communication with a destination specified by the address information, as illustrated [sic. "illustrated"] by step 4.

'490 patent, col. 9, line 66-col. 10, line 15.

The specification then describes the connection processes when the "address information is (1) an Internet protocol address, (2) an E-mail address, or (3) a telephone number. The specification does not describe a connection process if the "address information is "other information."

For an "Internet protocol address," for example, the specification explains:

If the address information is an Internet protocol address, having the form XXX.XXX.XXX, the WebPhone client process 306 will attempt to establish a call directly to WebPhone client process 308.

'490 patent, col. 10, lines 20-24.

For an "E-mail address," the specification explains:

If the address information comprises an E-mail address, WebPhone client process 306 may first attempt to search the local directory associated with the WebPhone client process for a corresponding Internet protocol address. If not found, WebPhone client process 306 will attempt to connect with connection/information server 252 of FIG. 2B to obtain the corresponding [sic. corresponding] dynamically assigned Internet protocol address associated with the E-mail address. In such instance, WebPhone client process 306 supplies the E-mail address in packetized form to connection server 252. In response, if the process identified by the E-mail address is currently online and has a currently assigned Internet protocol address, connection server 252 will supply the Internet protocol address back to WebPhone client process 306 in packetized form. WebPhone client process 306 will then attempt to establish a connection to the second WebPhone client process 308 in a manner previously described. WebPhone client process 308 may be implemented as any process adhering to the WebPhone protocol, including an automatic call distribution system 242, a connection server 252, a gateway 218, etc.

'490 patent, col. 10, lines 24-44.

If the "address information" is a telephone number, the specification explains:

If the address information obtained by browser process 300 comprises a traditional PSTN telephone number, WebPhone client process 306 will supply the telephone number to connection server 252 of FIG. 2B. In one embodiment, connection server 252 recognizes the information as a telephone number and, using a look-up table algorithm matches a portion of the telephone number, such as the country code, area code or exchange, to an IP address representing a gateway which can establish a call over a circuit-switched network to the terminating apparatus represented by the telephone number. Such IP address is then returned to WebPhone client process 306. WebPhone client 306 then attempts to contact the gateway, e.g. gateway 218. In the illustrative embodiment, gateway 218 implements the WebPhone protocol and is capable of functioning as a WebPhone client process without a graphic user interface. In a manner previously described, gateway 218 then establishes a traditional call to the terminating apparatus specified by the telephone number and performs the functions of translating either analog or digital telephone signals to compressed packetized audio packets, and vice versa to effect communication between the WebPhone client process and the terminating apparatus, i.e., a telephone 214.

Alternatively, the telephone number may be supplied from WebPhone client process 306 to a domain name server which then resolves the telephone number into the Internet protocol address of the appropriate gateway, in a manner described in U.S. patent application Ser. No. 08/911,133, entitled Method and Apparatus for Establishing Communications Between Packet-Switched and Circuit-Switched Networks, by Keith C. Kelly, filed Aug. 14, 1997, and U.S. patent application Ser. No. 08/911,519, entitled Domain Name Server Architecture for Translating Telephone Number Domain Names into Network Protocol Addresses, by Keith C. Kelly, filed Aug. 14, 1997. The IP address is then returned to WebPhone client process 306 which then contacts the gateway represented by the IP address directly to establish the call to the terminating apparatus on the TSTN network, in the manner described above.

'490 patent, col. 10, line 45-col. 11, line 16. There is no description of using "other information" to establish a connection, or in the terms of claim 1 "initiating with the computer telephony communication utility a real-time audio communication connection *with the destination identified by the address information,*"

where the "address information" is something other than (1) an Internet protocol address, (2) an E-mail address, or (3) a telephone number.

Indeed, the next paragraph in the specification says:

Utilizing the method described above, a user of a web browser utility may single click on an icon representing an HTML tag on a web page and, using the technique described herein seamlessly establish a real-time communication with either an automatic call distribution center associated with the website over a packet-switched data network or with a traditional automatic call distribution system over a telephone line.

'490 patent, col. 11, lines 17-24. The "method described above" does not include "address information" other than (1) an Internet protocol address, (2) an E-mail address, or (3) a telephone number.

The Court is mindful that during prosecution, in a response of April 27, 2001, the applicants stated in an After Final Response that "[g]enerally, upon request from a user, the browser process retrieves address information from a web site. Such address information can be in the form of an internet protocol address, an e-mail address, a telephone number or other information, any of which may be stored in the form of an HTML tag (page 17, lines 4-6)." (Doc. 87-17 at 12). That comment appears in an "Amendment After Final Action Under 37 C.F.R. s. 1.116." There is a hand-written notation "O.K. to enter" which presumably comes from the examiner. However, the parties have not provided the Court with the entire prosecution history, and the context of that statement, especially given that the statement was made in after a final rejection, remains in doubt. The Court has considered the statement in the context of the parties' briefs and their oral presentations at the *Markman* hearing, and is not persuaded that that statement trumps the explanation given in the specification. However, the Court is open to reconsidering its conclusion if the parties request.

With respect to Net2Phone's argument that "the Background of the Invention removes any ambiguity regarding whether other information is included in 'address information' by providing that 'other information' can be address information to the extent that it is retrieved from a website and used to establish a communication with a destination," (Doc. No. 92 at 14) (citing '490 patent, col. 3, lines 39-44), that paragraph of the specification says in whole:

A further need exists for the ability to utilize information, such as Internet protocol addresses, telephone numbers, E-mail addresses and other information which may be posted on the Internet to efficiently establish a communication link between a software application, such as a browser, and a source posting of such information.

A "need" may exist for "the ability to utilize ... other information" to "efficiently establish a communication link between a software application, such as a browser, and a source posting of such information," but that is not what the patentees equate to "address information" in the specification.

With respect to *Pfizer*, the Federal Circuit in distinguishing *Abbott*, noted that "the court did not identify any support in the intrinsic evidence for a construction of the disputed claim term other than the construction linked to 'i.e.' " Here, the Court has considered each of the instances in which the patentees referred to "address information" in the specification, and none extend "address information" beyond (1) an Internet protocol address, (2) an E-mail address, or (3) a telephone number. In *Pfizer*, the patent-in-suit included a section entitled "SACCHARIDES" with the following disclosure:

The saccharide components to be used in the pharmaceutical products and methods of the invention are substances which are compatible with the alkali or alkaline earth metal-containing stabilizers. Generally, they are substances which do not contain groups which could significantly interfere with the function of either the metal-containing component or the drug component. Mannitol, lactose, and other sugars are preferred. Mixtures are operable.

The Federal Circuit concluded that a reference to "saccharides (i .e., sugars)" did not constitute a definition of "saccharides" in light of the broader disclosure of "saccharides." Although a separate section of the specification is certainly not required, as was the case in *Pfizer*, none of the portions of the specification that Net2Phone references suggests that "address information," within the disclosure of the '490 patent, means other than (1) an Internet protocol address, (2) an E-mail address, or (3) a telephone number.

c) Conclusion

In view of the foregoing, the Court concludes that:

In the asserted claims of the '490 patent, "address information" means "an Internet Protocol address, an E-mail address or a telephone number."

2. "retrieving with a browser process executing on the computer system, address information usable in establishing a real-time audio communication connection with a destination" and "browser program code configured to obtain address information usable in establishing a real-time audio communication connection with a destination"

This phrase appears in claims 1 and 18. Claim 1 is deemed representative (the disputed term is in boldface):

1. A method for establishing real-time audio communications between a process executing on a computer system coupled to a packet-switched network and an information source coupled to either a packet-switched data network or terminating apparatus on a circuit-switched communication network, the method comprising:

A. retrieving, with a browser process executing on the computer system, address information usable in establishing a real-time audio communication connection with a destination;

B. supplying the address information from the browser process to a computer telephony communication utility associated with the browser process; and

C. initiating with the computer telephony communication utility a real-time audio communication connection with the destination identified by the address information.

The relevant language in claim 18 is "browser program code configured to obtain address information usable in establishing a real-time audio communication connection with a destination." The parties do not contend that the claims should receive different constructions.

a) The Parties' Proposed Constructions

The parties propose the following constructions:

<i>eBay</i>	<i>IDT</i>
A browser process executing on the computer system downloading [or browser program code configured to download] address information from a website in a form that, when selected, can establish a real-time audio communication connection with a destination.	No construction is necessary.

See Doc. No. 99 at 89 (JCCC Exhibit 1 at 87).

Net2Phone provided a proposed construction during briefing, but in the JCCC contended that no construction was necessary. Net2Phone during briefing contended that eBay's construction "address information ... *when selected*, can establish a real-time audio communication connection with a destination" injected a limitation not required by the intrinsic record. Net2Phone argued that "[t]he specification makes it abundantly clear that *selecting* of address information does not alone or immediately establish a real-time audio communication with a destination." ... In other words, the address information is supplied to a computer telephony program that *uses* the address information to establish a communication link." (Doc. No. 83 at 30) (emphasis by Net2Phone). Net2Phone also argued that eBay's proposed construction was wrong "because the claim term 'retrieving' is not limited to 'downloading.' Nothing in the intrinsic or extrinsic evidence supports such a limitation. Although downloading is one way to 'retrieve' address information, nothing in the '490 Patent limits or requires 'retrieving' the address information by 'downloading.' " (Doc. No. 83 at 30-31).

eBay contends that this is a "fundamental feature" of the invention of the '490 patent. According to eBay, "[a]s described in the specification, the 'invention' involves using a web browser to download address information as an HTML tag.... The specification explains, '[o]ne or more of the pages accessible on web server 260 may contain address information in the form of a hypertext markup language (HTML) tag which may be downloaded over the Internet 220 to a browser process....' ... This causes the address information to be displayed graphically in the user's web browser, typically as an icon or link.... The user can then select the address information by clicking on that icon or link and thereby establish a call within the destination identified by the address information. As explained in the Summary of the Invention, 'the present invention provides a method by which iconical or other graphical representations of a destination may be selected with a pointing device from a computer system and a call established between a browser user and a destination identified on a website.' " (Doc No. 87 at 42). eBay argues that its proposed construction "tracks the specification in providing that the address information is *downloaded* in a form that, when *selected*, can be used to establish a real-time audio communication with a destination." Id. at 43(emphasis by Net2Phone). eBay urges that Net2Phone's proposed construction is largely a repetition of the claim language. Id.

Net2Phone responds that "[b]ased on the parties' agreed construction for 'browser process' and 'browser program code,' and the discussion of 'address information' above, Net2Phone contends that the only remaining terms in the phrases at issue, 'retrieving' and 'obtain,' should be given their plain meaning." Net2Phone contends that " 'retrieving' and 'obtain' are synonymous and simply mean '[t]o obtain a specific requested item or set of data by locating and returning it to a program or to the user,' citing Microsoft Office Press Dictionary (3rd ed.1997) at 410. According to Net2Phone, "eBay's construction defines 'retrieving' and 'obtain' as 'downloading,' but downloading is only one way that address information can be retrieved.... Data can be retrieved through other ways, including, for example, remote procedure call, streaming, and asynchronous notification." (Doc. No. 92 at **15-16**) (emphasis by eBay).

eBay responds in its sur-reply that "Net2Phone complains that eBay's constructions are too narrow in that

they require the web browser to 'download' address information.... But that is exactly how the invention is described throughout the specification.... Tellingly, Net2Phone does not provide *a single citation to the specification* in support of a broader construction for these claim elements.... Instead, Net2Phone relies exclusively on a dictionary definition for the words 'retrieving' and 'obtaining.' ... This is improper." (Doc. No. 95 at 16).

b) Discussion

Once again, the claim language:

1. A method for establishing real-time audio communications between a process executing on a computer system coupled to a packet-switched network and an information source coupled to either a packet-switched data network or terminating apparatus on a circuit-switched communication network, the method comprising:

A. retrieving, with a browser process executing on the computer system, address information usable in establishing a real-time audio communication connection with a destination;

does not *per se* resolve the dispute. The claim simply calls for "retrieving ... address information."

Net2Phone draws a distinction between "retrieving" or "obtaining" and "downloading." And contends that in the '490 patent, "retrieving" or "obtaining" does not include "downloading," but does not offer a clear distinction. For example, prior to saying in the JCCC that "[n]o construction is necessary, Net2Phone contended that "retrieving with a browser process" meant "executing" or "running" a program in a browser," and that the "plain meaning" of "retrieving" was "simply 'retrieving' or 'obtaining.'" Net2Phone additionally contended that MICROSOFT PRESS'S COMPUTER DICTIONARY defined "retrieve" as "[t]o obtain a specific requested item or set of data by locating it and returning it to a program or user." (Doc. No. 83 at 30).

Although there may be a distinction between "retrieving" or "obtaining," on the one hand, and "downloading" on the other hand, generally, it is not at all clear what distinction Net2Phone draws in the context of the invention of the '490 patent. For example, one widely quoted source defines "download" in the field of computer science as "[t]o transfer a program or data file from a central computer to a remote computer or to the memory of an intelligent terminal." MCGRAW-HILL DICTIONARY OF SCIENTIFIC AND TECHNICAL TERMS (5th ed.1994) at 610, defining "down load." Net2Phone's reference to MICROSOFT PRESS'S COMPUTER DICTIONARY talks in terms of "re turning" the "requested item or set of data" to the "program or user." It is not immediately apparent how that differs from "downloading" the "requested item or set of data" to the "program or user."

Although the "address information" may not technically comprise a "program" or "data file," there is little doubt that the specification refers to "downloading" "address information." For example, the specification explains that "[o]ne or more of the pages accessible on web server 260 may contain address information in the form of a hypertext markup language (HTML) tag which may be downloaded over the Internet 220 to a browser process executing on any of the systems executing WebPhone client 232. Such HTML tag may include the IP address or E-mail address of automatic call distribution server, such as ACD 242, associated with the website." '490 patent, col. 9, lines 53-60.

As a result, the Court declines to adopt Net2Phone's contention that "[n]o construction is necessary." *See* O2 Micro Int'l Ltd. v. Beyond Innovation Tech. Co., 521 F.3d 1351, 1361 (Fed.Cir.2008) ("A determination that a claim term 'needs no construction' or has the 'plain and ordinary meaning' may be inadequate when a term has more than one 'ordinary' meaning or when reliance on a term's 'ordinary' meaning does not resolve the parties' dispute.").

The Court notes, however, that simply declining to accept Net2Phone's "[n]o construction is necessary" argument, does not mean that the Court is obliged to adopt eBay's construction. In fact, exactly the opposite. *See* Exxon Chemical Patents, Inc. v. Lubrizol Corp., 64 F.3d 1553, 1555 (Fed.Cir.1995) ("The duty of the trial judge is to determine the meaning of the claims at issue, and to instruct the jury accordingly.... In the exercise of that duty, the trial judge has an independent obligation to determine the meaning of the claims, notwithstanding the views asserted by the adversary parties.").

Here, the disputed claim limitation calls for:

retrieving, with a browser process executing on the computer system, address information usable in establishing a real-time audio communication connection with a destination;

Although the claim uses the word "retrieving," the specification does not use the word "retrieve" or its variants. Rather, the word used in the specification is "obtain" and its variants. For example, the abstract says "[a] technique for initiating communications from a web browser to a destination ... includes a communication utility capable of interacting with a browser utility and responsive to address information obtained from a website for establishing a communication link with the website ..." The specification also says "[i]n accordance with a second aspect of the invention, a computer program product usable with a computer system operatively coupled to a computer network comprises a computer usable medium having programming code embodied in the medium, the program code comprising program code configured to obtain address information about a destination from a source coupled to the computer system over a computer network, program code for establishing communications with the destination, program code for supplying the address information to the program code for establishing the communication connection, ..." '490 patent, col. 4, lines 16-26.

The specification also uses "download" in the following context: "One or more of the pages accessible on web server 260 may contain address information in the form of a hypertext markup language (HTML) tag which may be downloaded over the Internet 220 to a browser process executing on any of the systems executing WebPhone client 232. Such HTML tag may include the IP address or E-mail address of automatic call distribution server, such as ACD 242, associated with the website." '490 patent, col. 9, lines 53-60.

Thus the dispute appears to be between the meaning of "retrieve" which is the word used in the claim, and "download" which is used in eBay's proposed construction and the specification, yet the parties offer no explanation for the distinction *vis-a-vis* any issue in this case. *See* Lava Trading, Inc. v. Sonic Trading Mgmt., LLC, 445 F.3d 1348, 1350 (Fed.Cir.2006) ("In addition, this record on appeal does not supply any meaningful comparison of the accused products to the asserted claims. Without knowledge of the accused products, this court cannot assess the accuracy of the infringement judgment under review and lacks a proper context for an accurate claim construction."); *Wilson Sporting Goods Co. v. Hillerich & Bradsby Co.*, 442 F.3d 1322, 1326 (Fed.Cir.2006) ("While a trial court should certainly not prejudge the ultimate infringement analysis by construing claims with an aim to include or exclude an accused product or process, knowledge of that product or process provides meaningful context for the first step of the infringement

analysis, claim construction.").

Despite the insufficient state of the parties' submissions, and given the current record, especially Net2Phone's failure to provide any meaningful distinction between "retrieving," as used in claim 1, and "downloaded" as used in the specification, the Court construes "retrieving" in "retrieving, with a browser process executing on the computer system, address information usable in establishing a real-time audio communication connection with a destination" to mean "downloading" absent further submissions from the parties. Similarly, in the absence of further submissions from the parties, the Court construes "obtain" in claim 18 calling for "browser program code configured to obtain address information usable in establishing a real-time audio communication connection with a destination" to mean "downloading."

c) Conclusion

In view of the foregoing, the Court concludes that:

The term "retrieving" in claim 1 of the '490 patent calling for "retrieving, with a browser process executing on the computer system, address information usable in establishing a real-time audio communication connection with a destination" means "downloading." The term "obtain" in claim 18 of the '490 patent calling for "browser program code configured to obtain address information usable in establishing a real-time audio communication connection with a destination" similarly means "downloading."

The Court does not foreclose reconsidering that construction based on further submissions from the parties.

VI.

Order

This is the Court's Claim Construction Order with respect to the '350, '414, '399 and '490 patents. This Order is based on the current record before the Court. The Court does not foreclose reconsideration for good cause.

IT IS SO ORDERED, this 10th day of June, 2009.

Produced by Sans Paper, LLC.